

PROJECT-OUT WINDOW 3-8

OUTSWING CASEMENT WINDOW 9-14

Laws and building and safety codes governing the design and use of glazed entrance, window, and curtain wall products vary widely. Kawneer does not control the selection of product configurations, operating hardware, or glazing materials, and assumes no responsibility therefor.

Kawneer reserves the right to change configuration without prior notice when deemed necessary for product improvement.
© Kawneer Company, Inc., 2015

LAWS AND BUILDING AND SAFETY CODES GOVERNING THE DESIGN AND USE OF GLAZED ENTRANCE, WINDOW, AND CURTAIN WALL PRODUCTS VARY WIDELY. KAWNEER DOES NOT CONTROL THE SELECTION OF PRODUCT CONFIGURATIONS, OPERATING HARDWARE, OR GLAZING MATERIALS, AND ASSUMES NO RESPONSIBILITY THEREFOR.

Metric (SI) conversion figures are included throughout these details for reference. Numbers in parentheses () are millimeters unless otherwise noted.

The following metric (SI) units are found in these details:

- m – meter
- cm – centimeter
- mm – millimeter
- s – second
- Pa – pascal
- MPa – megapascal

Kawneer reserves the right to change configurations without prior notice when deemed necessary for product improvement.

Laws and building and safety codes governing the design and use of glazed entrance, window, and curtain wall products vary widely. Kawneer does not control the selection of product configurations, operating hardware, or glazing materials, and assumes no responsibility therefor.

Kawneer reserves the right to change configuration without prior notice when deemed necessary for product improvement.
© Kawneer Company, Inc., 2015

Features

- Heavy Commercial Grade Window
- Tested to US Standards
- 45° Mitered Vent and Frame Corners
- Staked Corner Joinery
- Architectural Anodized Finishes and Applied Coatings

Laws and building and safety codes governing the design and use of glazed entrance, window, and curtain wall products vary widely. Kawneer does not control the selection of product configurations, operating hardware, or glazing materials, and assumes no responsibility therefor.

Kawneer reserves the right to change configuration without prior notice when deemed necessary for product improvement.
© Kawneer Company, Inc., 2015

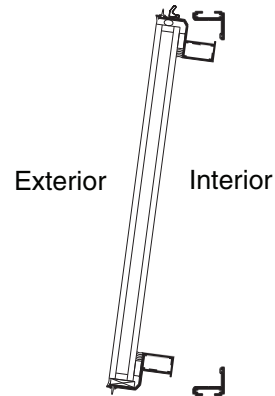
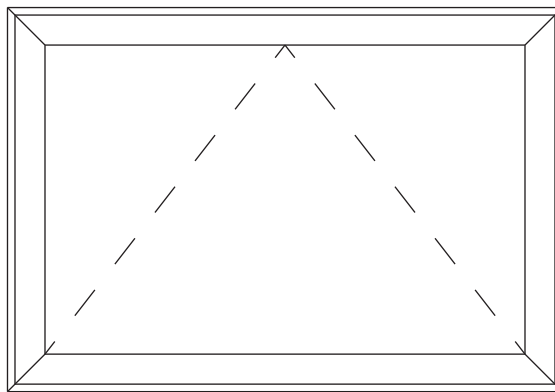

For specific product applications,
Consult your Kawneer representative.

| | |
|-------------------------------|---|
| CLASS and GRADE | Heavy Commercial Grade P-HC40 – P-HC70 |
| TESTING STANDARD | AAMA / WDMA / CSA / 101 / I.S.2 / A440 (NAFS) |
| SYSTEM DEPTH | 2-3/4" Overall System Depth (1" Infill) 2-1/8" Overall System Depth (1/4" Infill) |
| TYPICAL WALL THICKNESS | 0.090 Nominal Frame |
| TYPICAL MAX. VENT SIZE | 60" x 36" |
| TYPICAL MIN. VENT SIZE | 14" x 14" |
| INFILL OPTIONS | 1" and 1/4" |
| STANDARD HARDWARE | Stainless Steel 4-Bar Hinges Cast White Bronze Cam Lock |
| OPTIONAL HARDWARE | Cam Lock with Pole Ring Sash Pole Pole Ring Access Control Lock Pivot-Shoe Roto-Operator Concealed Lock with removable key Hook Bolt Lock Limit Stop |
| OTHER OPTIONS | Insect Screens |

Laws and building and safety codes governing the design and use of glazed entrance, window, and curtain wall products vary widely. Kawneer does not control the selection of product configurations, operating hardware, or glazing materials, and assumes no responsibility therefor.

Kawneer reserves the right to change configuration without prior notice when deemed necessary for product improvement.
© Kawneer Company, Inc., 2015

SCALE 3" = 1'-0"

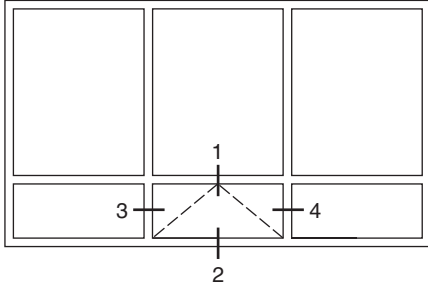

ELEVATION IS NUMBER KEYED TO DETAILS

1
HEAD

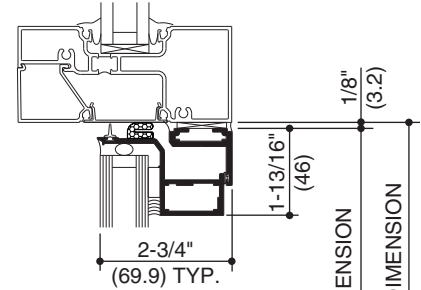

2
SILL

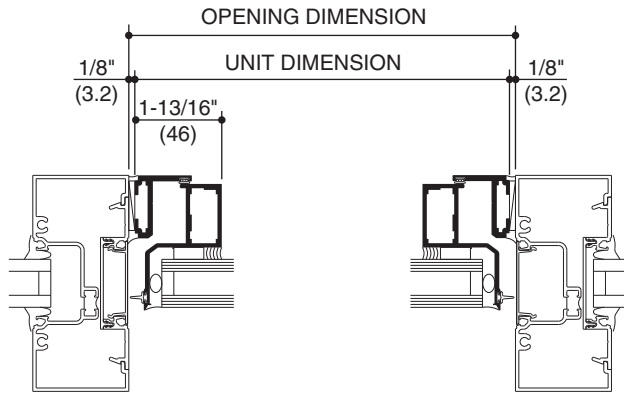
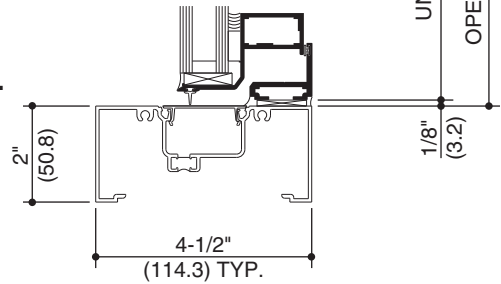

3
JAMB

4
JAMB

NOTE: THE KAWNEER GLASSvent™ WINDOW IS SHOWN IN THESE DETAILS WITH TRIFAB™ VG 451T STOREFRONT FRAMING FOR REFERENCE. OTHER KAWNEER SYSTEMS CAN BE USED. FOR PRODUCT SPECIFIC APPLICATIONS CONSULT YOUR KAWNEER REPRESENTATIVE.

Laws and building and safety codes governing the design and use of glazed entrance, window, and curtain wall products vary widely. Kawneer does not control the selection of product configurations, operating hardware, or glazing materials, and assumes no responsibility therefor.

Kawneer reserves the right to change configuration without prior notice when deemed necessary for product improvement.
© Kawneer Company, Inc., 2015

SCALE 3" = 1'-0"

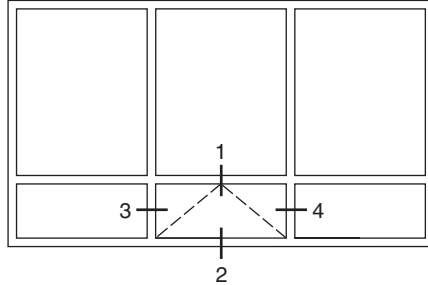

ELEVATION IS NUMBER KEYED TO DETAILS

1 HEAD

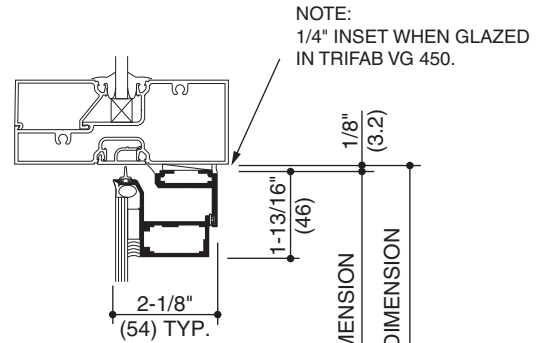

2 SILL

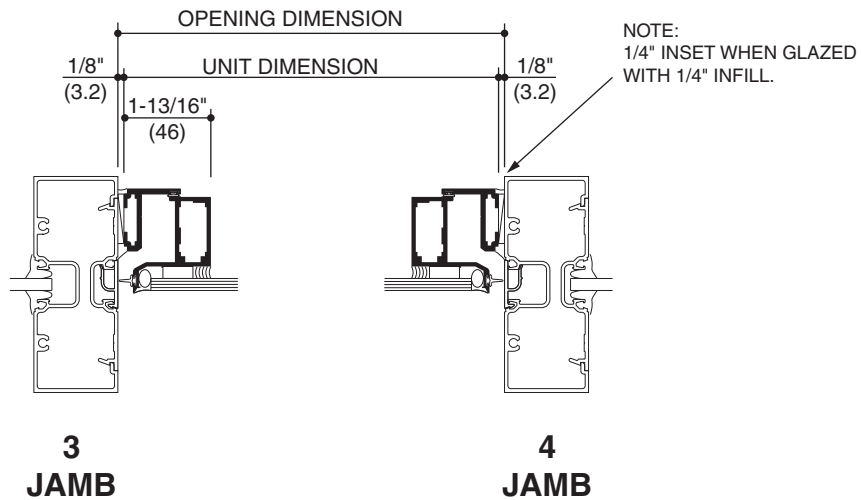
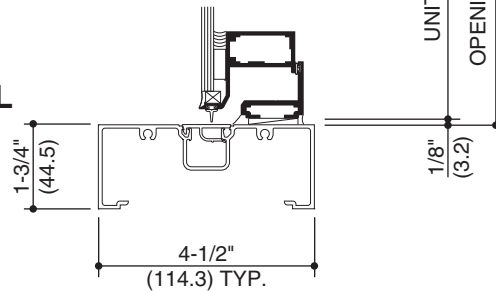

3 JAMB

4 JAMB

NOTE: THE KAWNEER GLASSvent™ WINDOW IS SHOWN IN THESE DETAILS WITH TRIFAB™ VG 451T STOREFRONT FRAMING FOR REFERENCE. OTHER KAWNEER SYSTEMS CAN BE USED. FOR PRODUCT SPECIFIC APPLICATIONS CONSULT YOUR KAWNEER REPRESENTATIVE.

Laws and building and safety codes governing the design and use of glazed entrance, window, and curtain wall products vary widely. Kawneer does not control the selection of product configurations, operating hardware, or glazing materials, and assumes no responsibility therefor.

Kawneer reserves the right to change configuration without prior notice when deemed necessary for product improvement.
© Kawneer Company, Inc., 2015

**STAINLESS STEEL
4 BAR HINGES**

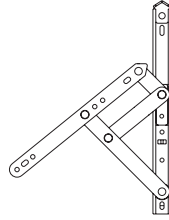

A standard hinge for ventilators providing approximately 45° to 60° openings depending on size. An optional limit stop is available to restrict hinge travel and limit vent opening.

CAM HANDLE

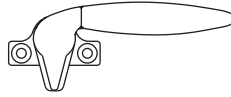

Cast white bronze cam handles are standard for the manual operation and locking of ventilators.

**CAM HANDLE
WITH POLE RING**

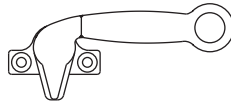

Cast white bronze cam handles with pole ring provide manual operation of ventilators located above reach. These handles are operated with a sash pole.

POLE RING



Cast white bronze pole ring is used in conjunction with locking hardware for sash pole operation of ventilators.

SASH POLE

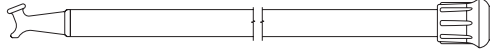

A 3/4" diameter aluminum sash pole with a cast white bronze pull down hook and black rubber tip. Available in 6 ft. and 12 ft. lengths with optional cast white bronze Pole Hanger.

**HANGER
FOR SASH POLE**



**ACCESS CONTROL
LOCK**

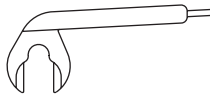

In lieu of cam handles cast white bronze access control locks are offered for managed control of vent operations. Lock is operated with a manganese bronze removable handle.

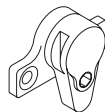

**PIVOT-SHOE
ROTO-OPERATOR**

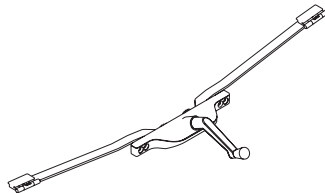

Optional pivot shoe roto operator is located on the center line of the bottom horizontal frame. Standard finish shall be brushed copper nickel to match US-25-D

HOOK BOLT LOCK



For use with pivot-shoe roto operator in lieu of cam handles. Standard finish shall be US-25-D clear white bronze.

Laws and building and safety codes governing the design and use of glazed entrance, window, and curtain wall products vary widely. Kawneer does not control the selection of product configurations, operating hardware, or glazing materials, and assumes no responsibility therefor.

Kawneer reserves the right to change configuration without prior notice when deemed necessary for product improvement.
© Kawneer Company, Inc., 2015

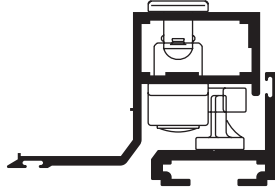
**CONCEALED
LOCK**

In lieu of cam handles cast white bronze concealed locks are offered for managed control of vent operations. Lock is operated with a removable key.

Laws and building and safety codes governing the design and use of glazed entrance, window, and curtain wall products vary widely. Kawneer does not control the selection of product configurations, operating hardware, or glazing materials, and assumes no responsibility therefor.

Kawneer reserves the right to change configuration without prior notice when deemed necessary for product improvement.
© Kawneer Company, Inc., 2015

Features

- Heavy Commercial Grade Window
- Tested to US Standards
- 45° Mitered Vent and Frame Corners
- Staked Corner Joinery
- Architectural Anodized Finishes and Applied Coatings

Laws and building and safety codes governing the design and use of glazed entrance, window, and curtain wall products vary widely. Kawneer does not control the selection of product configurations, operating hardware, or glazing materials, and assumes no responsibility therefor.

Kawneer reserves the right to change configuration without prior notice when deemed necessary for product improvement.
© Kawneer Company, Inc., 2015

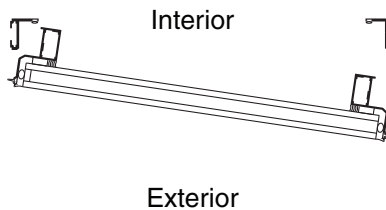
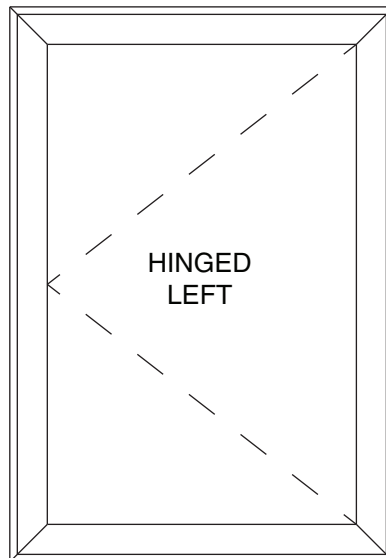

For specific product applications,
Consult your Kawneer representative.

| | |
|-------------------------------|---|
| CLASS and GRADE | Heavy Commercial Grade P-HC40 – P-HC70 |
| TESTING STANDARD | AAMA / WDMA / CSA / 101 / I.S.2 / A440 (NAFS) |
| SYSTEM DEPTH | 2-3/4" Overall System Depth (1" Infill) 2-1/8" Overall System Depth (1/4" Infill) |
| TYPICAL WALL THICKNESS | 0.090 Nominal Frame |
| TYPICAL MAX. VENT SIZE | 36" x 60" |
| TYPICAL MIN. VENT SIZE | 14" x 14" |
| INFILL OPTIONS | 1" and 1/4" |
| STANDARD HARDWARE | Stainless Steel 4-Bar Hinges Cast White Bronze Cam Handles |
| OPTIONAL HARDWARE | Cam Lock with Pole Ring SashPole Pole Ring Access Control Locks Multi-Point Lock Hook Bolt Lock Concealed Lock with removable key Limit Stop |
| OTHER OPTIONS | Insect Screens |

Laws and building and safety codes governing the design and use of glazed entrance, window, and curtain wall products vary widely. Kawneer does not control the selection of product configurations, operating hardware, or glazing materials, and assumes no responsibility therefor.

Kawneer reserves the right to change configuration without prior notice when deemed necessary for product improvement.
© Kawneer Company, Inc., 2015

SCALE 3" = 1'-0"

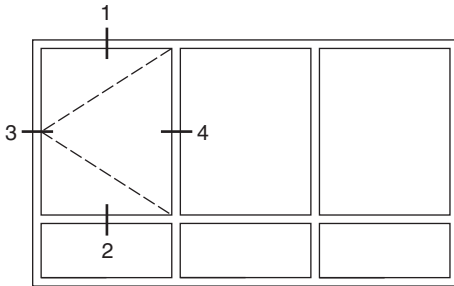

ELEVATION IS NUMBER KEYED TO DETAILS

**1
HEAD**

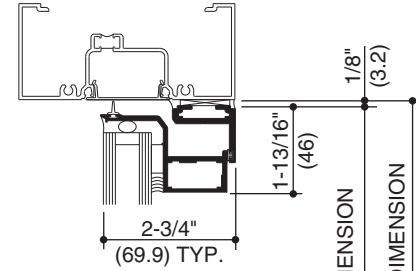

**2
SILL**

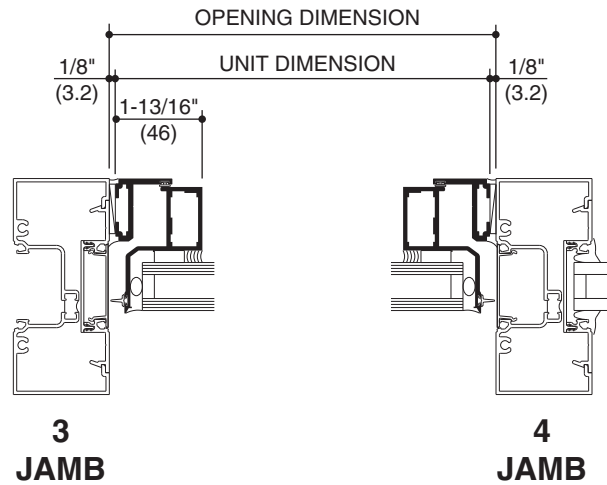
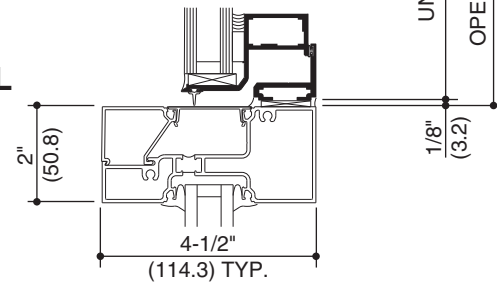

**3
JAMB**

**4
JAMB**

NOTE: THE KAWNEER GLASSvent™ WINDOW IS SHOWN IN THESE DETAILS WITH TRIFAB™ VG 451T STOREFRONT FRAMING FOR REFERENCE. OTHER KAWNEER SYSTEMS CAN BE USED. FOR PRODUCT SPECIFIC APPLICATIONS CONSULT YOUR KAWNEER REPRESENTATIVE.

Laws and building and safety codes governing the design and use of glazed entrance, window, and curtain wall products vary widely. Kawneer does not control the selection of product configurations, operating hardware, or glazing materials, and assumes no responsibility therefor.

Kawneer reserves the right to change configuration without prior notice when deemed necessary for product improvement.
© Kawneer Company, Inc., 2015

SCALE 6" = 1'-0"

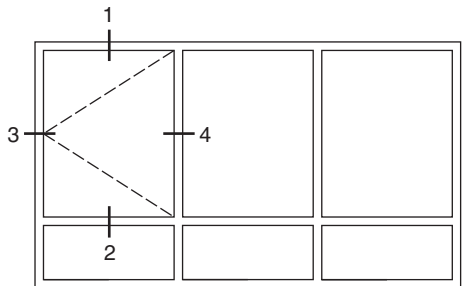

ELEVATION IS NUMBER KEYED TO DETAILS

NOTE:
1/4" INSET WHEN
GLAZED
IN TRIFAB VG 450.

1
HEAD

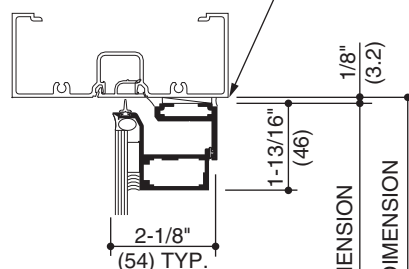

2
SILL

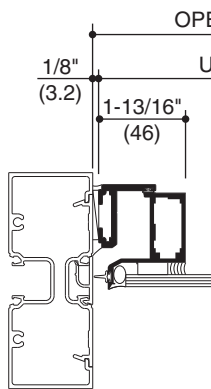
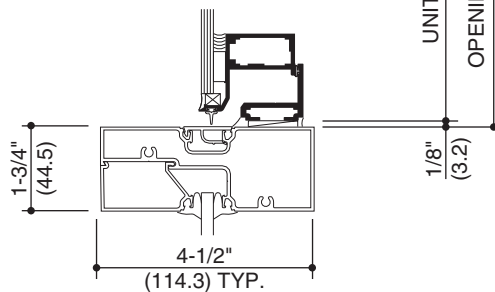

3
JAMB

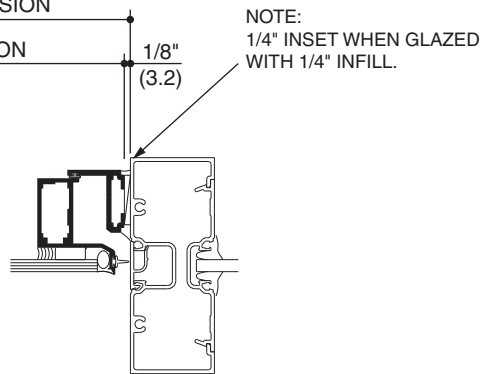

4
JAMB

NOTE: THE KAWNEER GLASSvent™ WINDOW IS SHOWN IN THESE DETAILS WITH TRIFAB™ VG 451T STOREFRONT FRAMING FOR REFERENCE. OTHER KAWNEER SYSTEMS CAN BE USED. FOR PRODUCT SPECIFIC APPLICATIONS CONSULT YOUR KAWNEER REPRESENTATIVE.

Laws and building and safety codes governing the design and use of glazed entrance, window, and curtain wall products vary widely. Kawneer does not control the selection of product configurations, operating hardware, or glazing materials, and assumes no responsibility therefor.

Kawneer reserves the right to change configuration without prior notice when deemed necessary for product improvement.
© Kawneer Company, Inc., 2015

**STAINLESS STEEL
4 BAR HINGES**

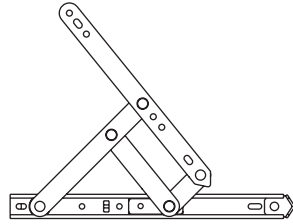

A standard hinge for ventilators providing approximately 45° to 60° openings depending on size. An optional limit stop is available to restrict hinge travel and limit vent opening.

CAM HANDLE

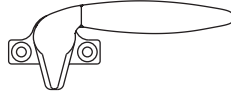

Cast white bronze cam handles are standard for the manual operation and locking of ventilators.

**CAM HANDLE
WITH POLE RING**

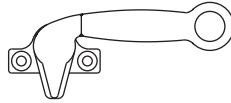

Cast white bronze cam handles with pole ring provide manual operation of ventilators located above reach. These handles are operated with a sash pole.

POLE RING



Cast white bronze pole ring is used in conjunction with locking hardware for sash pole operation of ventilators.

SASH POLE

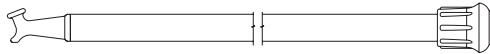

A 3/4" diameter aluminum sash pole with a cast white bronze pull down hook and black rubber tip. Available in 6 ft. and 12 ft. lengths with optional cast white bronze Pole Hanger.

**HANGER
FOR SASH POLE**



**ACCESS CONTROL
LOCK**

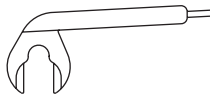

In lieu of cam handles cast white bronze access control locks are offered for managed control of vent operations. Lock is operated with a manganese bronze removable handle.

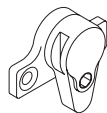

HOOK BOLT LOCK



For use with pivot-shoe roto operator in lieu of cam handles. Standard finish shall be US-25-D clear white bronze.

MULTI-POINT LOCK



Optional single locking handle for concealed multi-point locks located on the vertical frame. Standard finish shall be US-25-D clear white bronze.

Laws and building and safety codes governing the design and use of glazed entrance, window, and curtain wall products vary widely. Kawneer does not control the selection of product configurations, operating hardware, or glazing materials, and assumes no responsibility therefor.

Kawneer reserves the right to change configuration without prior notice when deemed necessary for product improvement.
© Kawneer Company, Inc., 2015

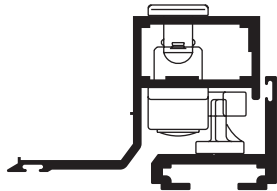
**CONCEALED
LOCK**

In lieu of cam handles cast white bronze concealed locks are offered for managed control of vent operations. Lock is operated with a removable key.

Laws and building and safety codes governing the design and use of glazed entrance, window, and curtain wall products vary widely. Kawneer does not control the selection of product configurations, operating hardware, or glazing materials, and assumes no responsibility therefor.

Kawneer reserves the right to change configuration without prior notice when deemed necessary for product improvement.
© Kawneer Company, Inc., 2015