

Features

- 190 narrow stile has 2-1/8" (54) vertical stile, 2-1/4" (57.2) top and 3-7/8" (98.4) bottom rail
- 350 medium stile has 3-1/2" (88.9) vertical stile, 3-1/2" (88.9) top and 6-1/2" (165.1) bottom rail
- 500 wide stile has 5" (127) vertical stile, 5" (127) top and 6-1/2" (165.1) bottom rail
- Door is 1-3/4" (44.5) deep
- Dual moment welded corner construction
- Single or double acting
- Infills range from 1/4" (6.4) to 1" (25.4)
- Offset pivots, butt hinges, continuous geared hinge or center pivots
- MS locks or panic hardware
- Surface mounted or concealed closers
- Architects Classic push/pulls
- Adjustable astragal utilizing pile weathering with polymeric fin at meeting stiles
- Polymeric bulb weatherstripping in door frames
- Permanodic® anodized finishes option
- Painted finishes in standard and custom choices

Optional Features

- Paneline® exit device or Paneline® MEL exit device
- Wide variety of bottom rail and cross rail

Product Applications

- 190 narrow stile - engineered for moderate traffic in applications such as offices and stores
- 350 medium stile - provides extra strength for schools, institutions and other high traffic applications
- 500 wide stile - creates a monumental visual statement for banks, libraries or buildings that experience heavy traffic conditions

For specific product applications,
consult your Kawneer representative.

Laws and building and safety codes governing the design and use of Kawneer products, such as glazed entrance, window, and curtain wall products, vary widely. Kawneer does not control the selection of product configurations, operating hardware, or glazing materials, and assumes no responsibility therefor.

Kawneer reserves the right to change configuration without prior notice when deemed necessary for product improvement.

© 2015, Kawneer Company, Inc.

Laws and building and safety codes governing the design and use of Kawneer products, such as glazed entrance, window, and curtain wall products, vary widely. Kawneer does not control the selection of product configurations, operating hardware, or glazing materials, and assumes no responsibility therefor.

Kawneer reserves the right to change configuration without prior notice when deemed necessary for product improvement.
© 2015, Kawneer Company, Inc.

PICTORIAL VIEW5

DOOR TYPES/SECT. DIMENSIONS6

CONSTRUCTION DETAILS7,8

STANDARD ENTRANCE PACKAGES10, 11

ENTRANCE OFFERINGS.....12, 13

APPLICATION CRITERIA.....13

PUSH PULL HARDWARE14

PANELINE®/PANELINE® MEL EXIT DEVICE.....15, 16

AUTO SHOWROOM DOOR17, 18

INTERMEDIATE RAILS19

INFILL OPTIONS19

ACCESSORIES19

HANDICAP ACCESSIBLE ITEMS.....20

BOTTOM RAILS21

THERMAL CHARTS 22-40

Metric (SI) conversion figures are included throughout these details for reference. Numbers in parentheses () are millimeters unless otherwise noted.

The following metric (SI) units are found in these details:

- m – meter
- cm – centimeter
- mm – millimeter
- s – second
- Pa – pascal
- MPa – megapascal

Laws and building and safety codes governing the design and use of Kawneer products, such as glazed entrance, window, and curtain wall products, vary widely. Kawneer does not control the selection of product configurations, operating hardware, or glazing materials, and assumes no responsibility therefor.

Kawneer reserves the right to change configuration without prior notice when deemed necessary for product improvement.
© 2015, Kawneer Company, Inc.

Laws and building and safety codes governing the design and use of Kawneer products, such as glazed entrance, window, and curtain wall products, vary widely. Kawneer does not control the selection of product configurations, operating hardware, or glazing materials, and assumes no responsibility therefor.

Kawneer reserves the right to change configuration without prior notice when deemed necessary for product improvement.
© 2015, Kawneer Company, Inc.

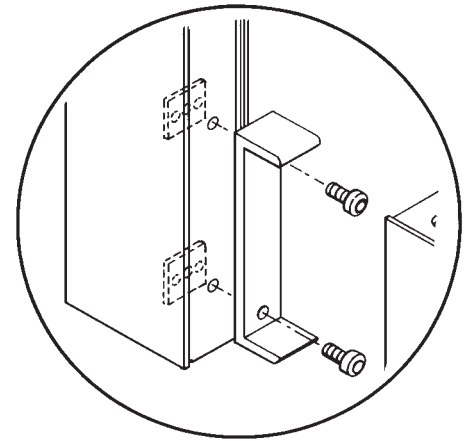
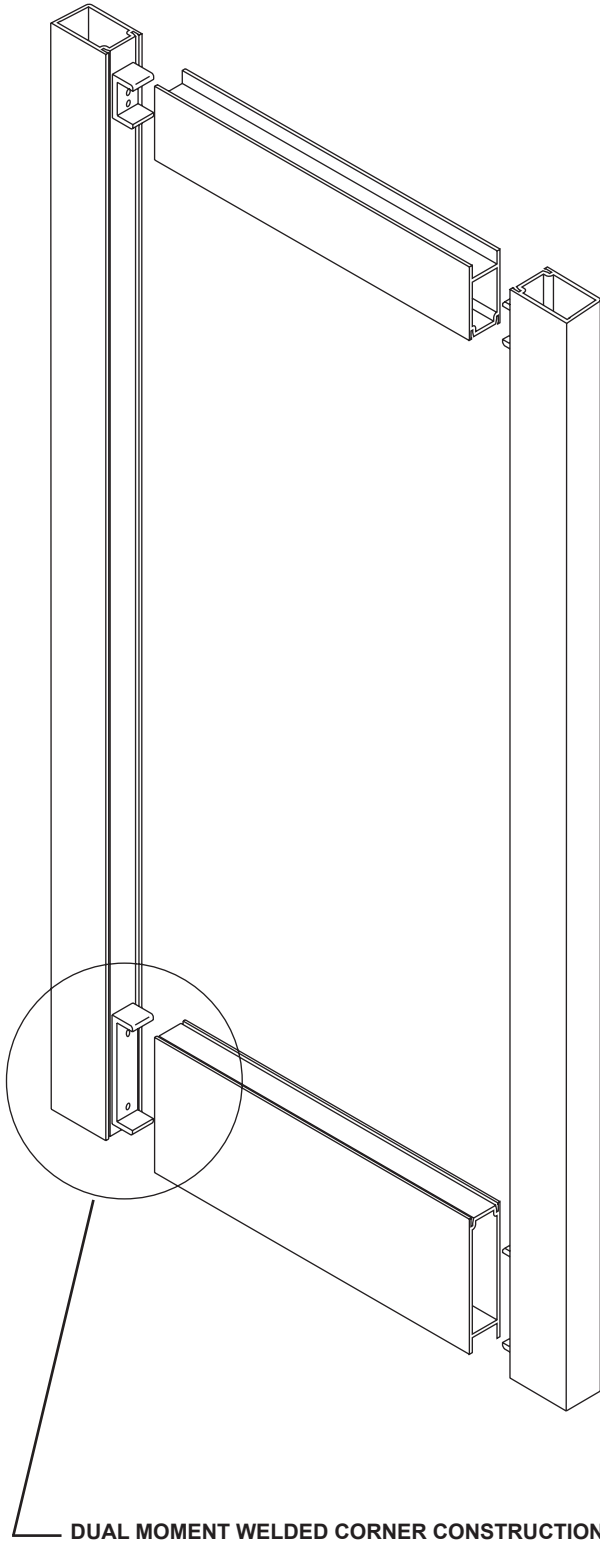

#1 MECHANICAL FASTENING is accomplished by attaching a 5/16" (7.9) thick extruded aluminum channel clip to the vertical stile with 1/4"-20 heat strengthened bolts and 3/16" thick steel nut plates for a high strength welding base for attachment horizontal member.

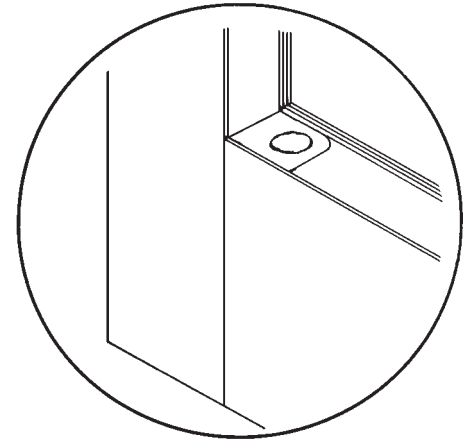

#2 SIGMA* DEEP PENETRATION PLUG WELDS are made top and bottom after the horizontal is properly positioned over the channel clip to help provide the strongest door corner joint currently available.

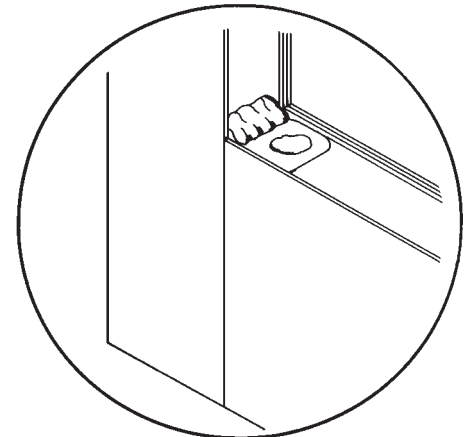

#3 SIGMA* FILLET WELDS along both top and bottom webs of the rail extrusion complete the welded corner construction.

* An arc welding process known as Shielded Inert Gas Metal Arc (SIGMA) or also known as Metal Inert Gas (MIG).

Additional information and CAD details are available at www.kawneer.com

190 NARROW STILE

350 MEDIUM STILE

500 WIDE STILE

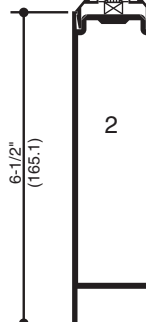
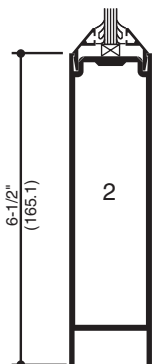
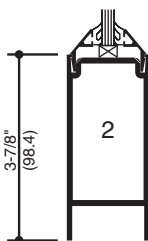
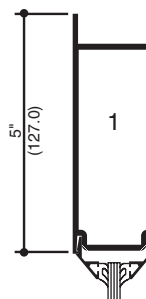
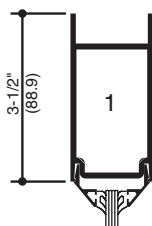
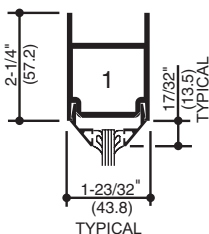
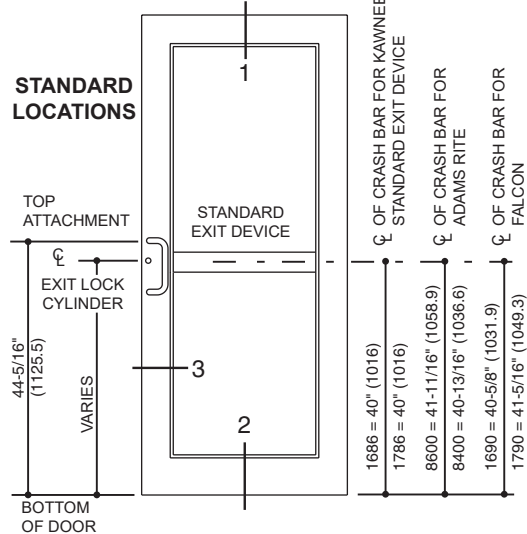
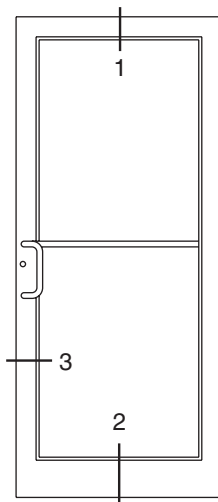
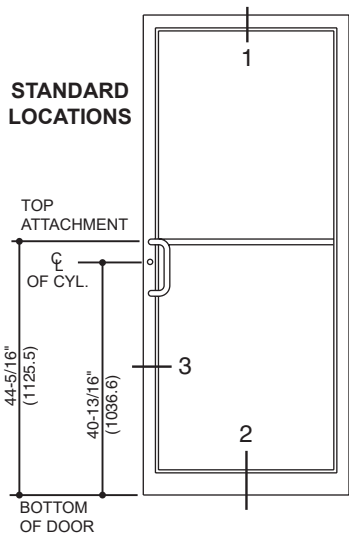

SINGLE ACTING

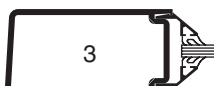

SINGLE ACTING



SINGLE ACTING

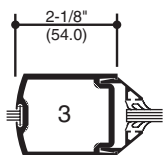

DOUBLE ACTING

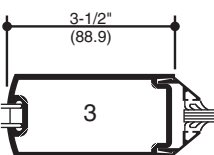

DOUBLE ACTING

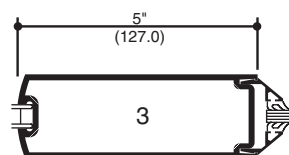

DOUBLE ACTING

Laws and building and safety codes governing the design and use of Kawneer products, such as glazed entrance, window, and curtain wall products, vary widely. Kawneer does not control the selection of product configurations, operating hardware, or glazing materials, and assumes no responsibility therefor.

Kawneer reserves the right to change configuration without prior notice when deemed necessary for product improvement.
 © 2015, Kawneer Company, Inc.

Additional information and CAD details are available at www.kawneer.com

NOTE:

- 1. SERIES 190 NARROW STILE DOORS ARE DETAILED, MEDIUM STILE 350 DOORS AND WIDE STILE 500 DOORS ALSO MAY BE USED.
- 2. TRIFAB® VERSAGLAZE® 450 CENTER, 1-3/4" X 4-1/2" (44.5 X 114.3) FRAMING IS DETAILED WITH THE DOORS FOR REFERENCE. OTHER KAWNEER FRAMING SERIES OR CURTAIN WALL SYSTEMS MAY BE USED. REFER TO THE CATALOG INDEX FOR THE APPROPRIATE DETAIL SECTION.

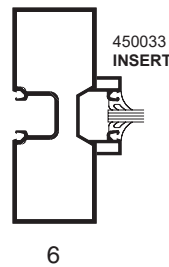
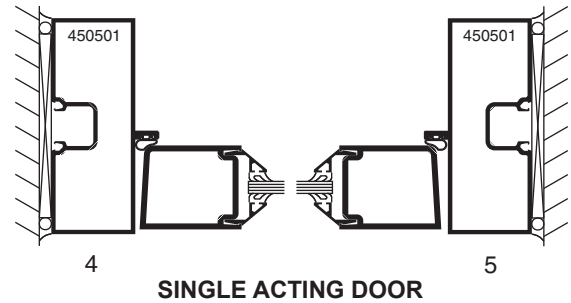
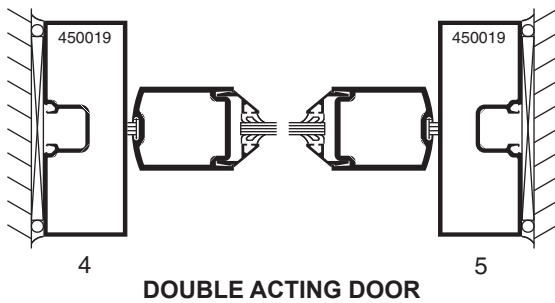
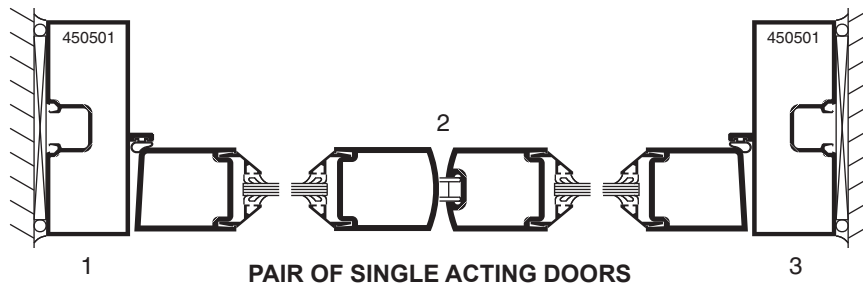
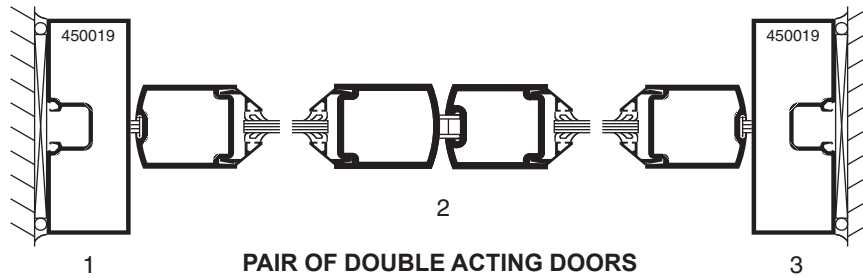
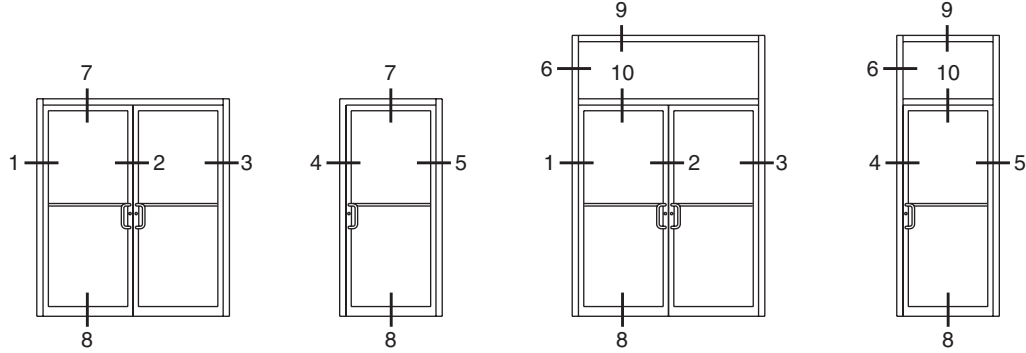

Laws and building and safety codes governing the design and use of Kawneer products, such as glazed entrance, window, and curtain wall products, vary widely. Kawneer does not control the selection of product configurations, operating hardware, or glazing materials, and assumes no responsibility therefor.

Kawneer reserves the right to change configuration without prior notice when deemed necessary for product improvement.
© 2015, Kawneer Company, Inc.

Additional information and CAD details are available at www.kawneer.com

DOUBLE ACTING DOORS

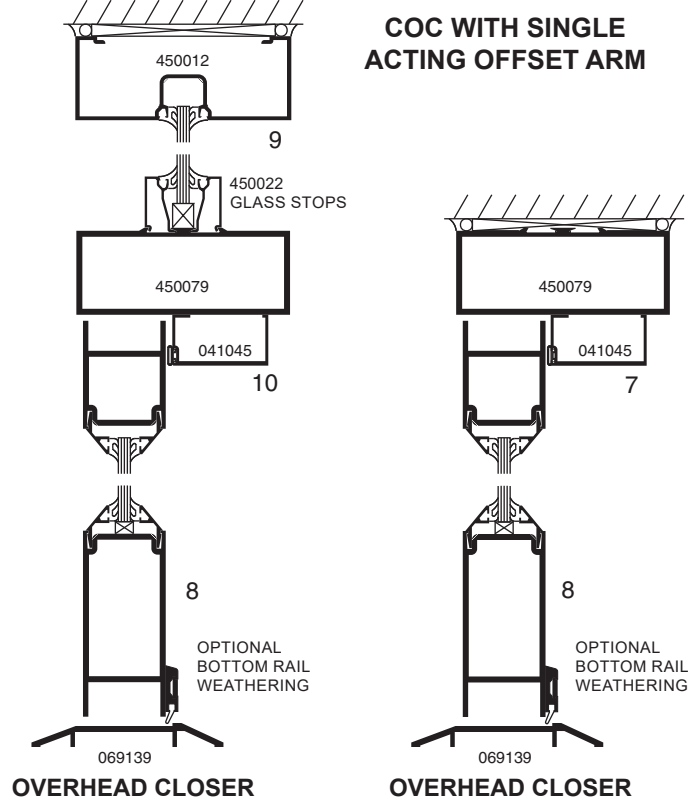
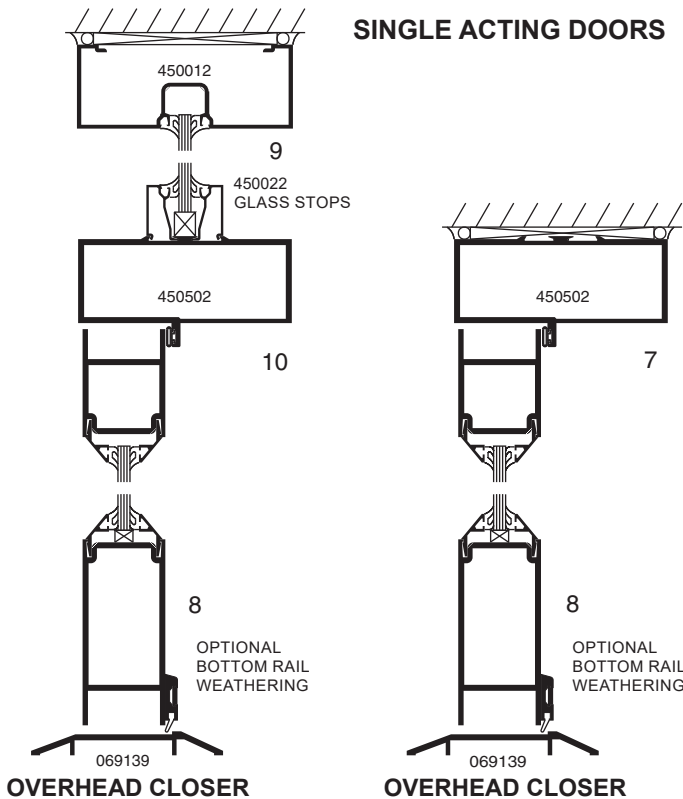
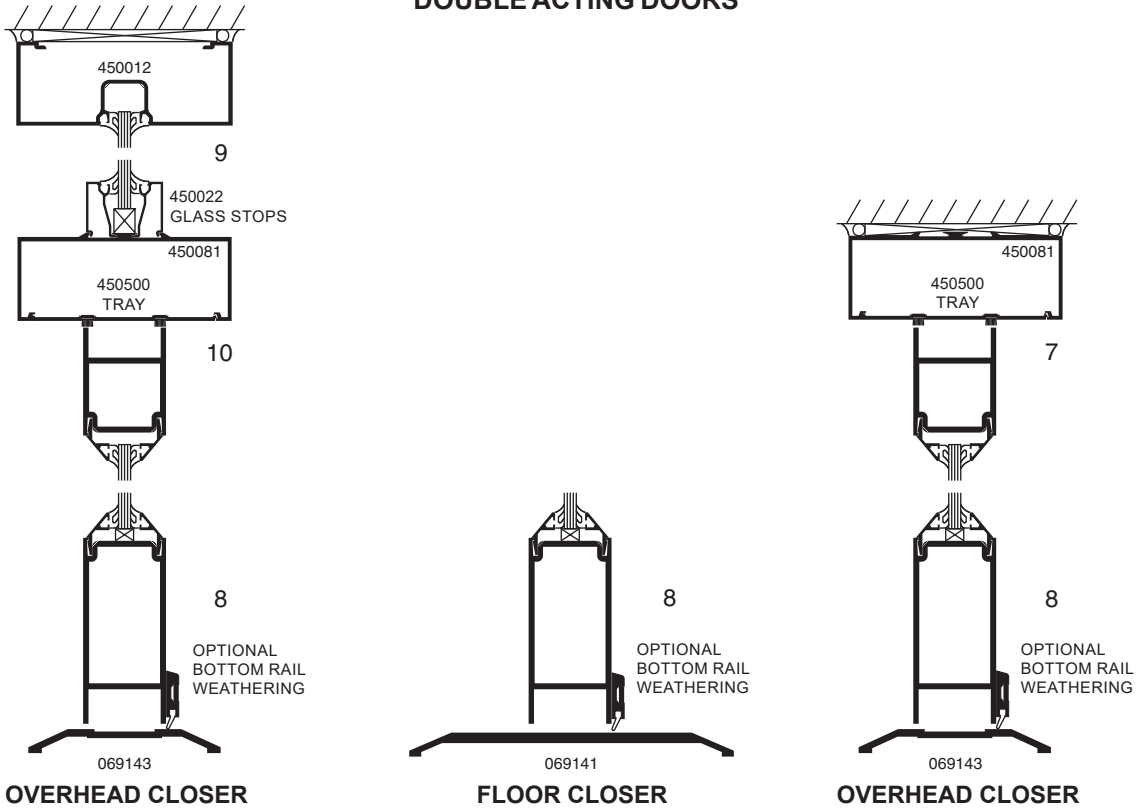

Laws and building and safety codes governing the design and use of Kawneer products, such as glazed entrance, window, and curtain wall products, vary widely. Kawneer does not control the selection of product configurations, operating hardware, or glazing materials, and assumes no responsibility therefor.

Kawneer reserves the right to change configuration without prior notice when deemed necessary for product improvement.
© 2015, Kawneer Company, Inc.

Laws and building and safety codes governing the design and use of Kawneer products, such as glazed entrance, window, and curtain wall products, vary widely. Kawneer does not control the selection of product configurations, operating hardware, or glazing materials, and assumes no responsibility therefor.

**LEFT BLANK
INTENTIONALLY**

Kawneer reserves the right to change configuration without prior notice when deemed necessary for product improvement.
© 2015, Kawneer Company, Inc.

Additional information and CAD details are available at www.kawneer.com

Trifab® VersaGlaze® 450 center door frames shown, Trifab® VersaGlaze® 451 center door frames similar.

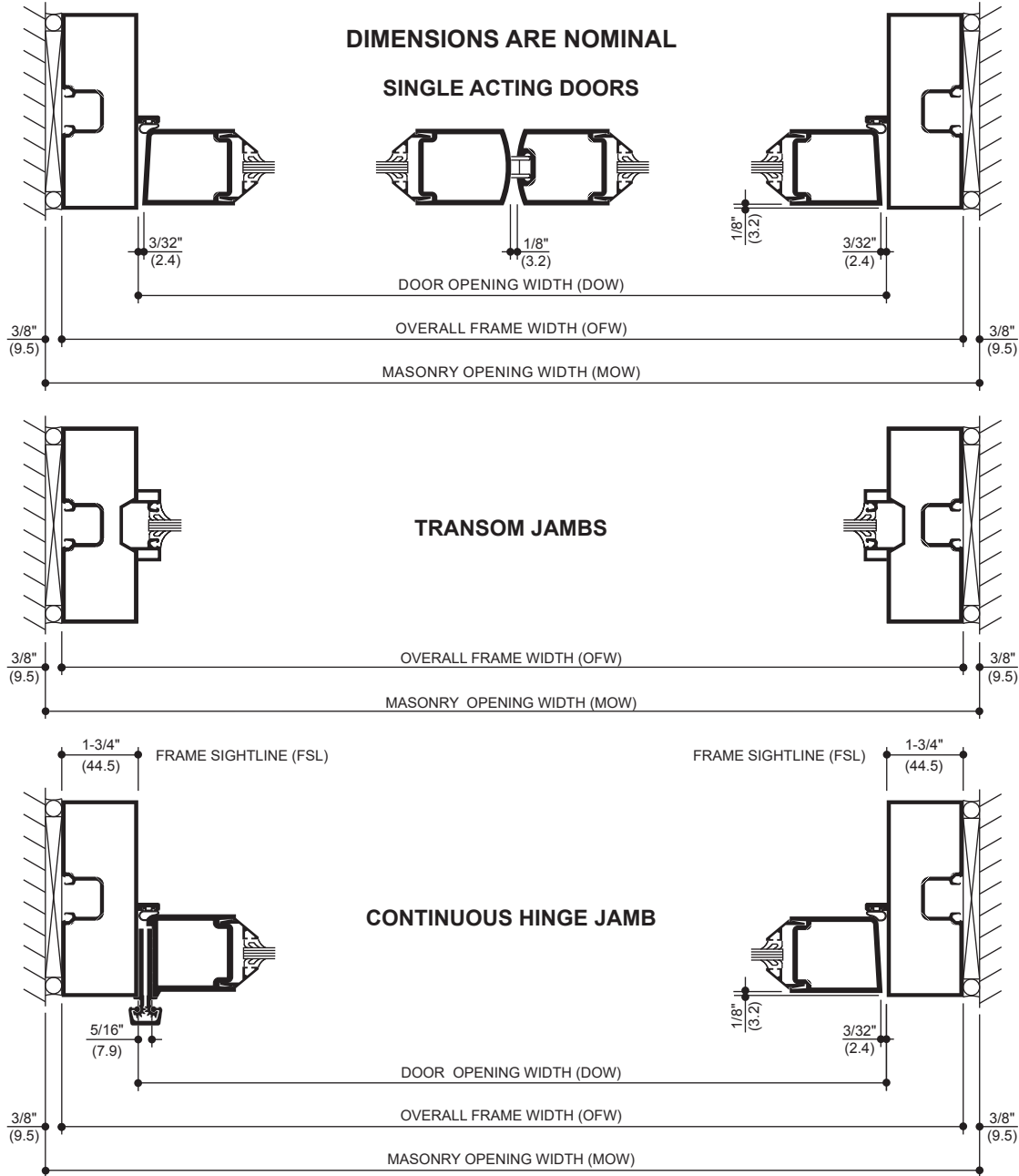

STANDARD SIZES (TRIFAB® 400 & TRIFAB® VG 450 CENTER FRAMES)

WITH AND WITHOUT TRANSOM

Door Opening Dimension (DOW)	Overall Frame Dimension (OFW)	Masonry Opening Dimension (MOW)
3' 0" (914)	3' 3-1/2" (1,003)	3' 4-1/4" (1,022)
3' 6" (1,067)	3' 9-1/2" (1,156)	3' 10-1/4" (1,175)
6' 0" (1,829)	6' 3-3/4" (1,924)	6' 4-1/4" (1,937)

STANDARD SIZES (TRIFAB® VG 451 CENTER FRAMES)

WITH AND WITHOUT TRANSOM

Door Opening Dimension (DOW)	Overall Frame Dimension (OFW)	Masonry Opening Dimension (MOW)
3' 0" (914)	3' 4" (1,016)	3' 4-3/4" (1,035)
3' 6" (1,067)	3' 10" (1,168)	3' 10-3/4" (1,187)
6' 0" (1,829)	6' 4" (1,930)	6' 4-3/4" (1,949)

WITH AND WITHOUT TRANSOM

OFW = DOW + 2 FSL

MOW = OFW + 3/4"

Note: Dimensions shown above reflect A1 Price Book standard stock door frame height with transom at 10' 3-1/2" (3,137).

Laws and building and safety codes governing the design and use of Kawneer products, such as glazed entrance, window, and curtain wall products, vary widely. Kawneer does not control the selection of product configurations, operating hardware, or glazing materials, and assumes no responsibility therefor.

Kawneer reserves the right to change configuration without prior notice when deemed necessary for product improvement.
© 2015, Kawneer Company, Inc.

Additional information and CAD details are available at www.kawneer.com

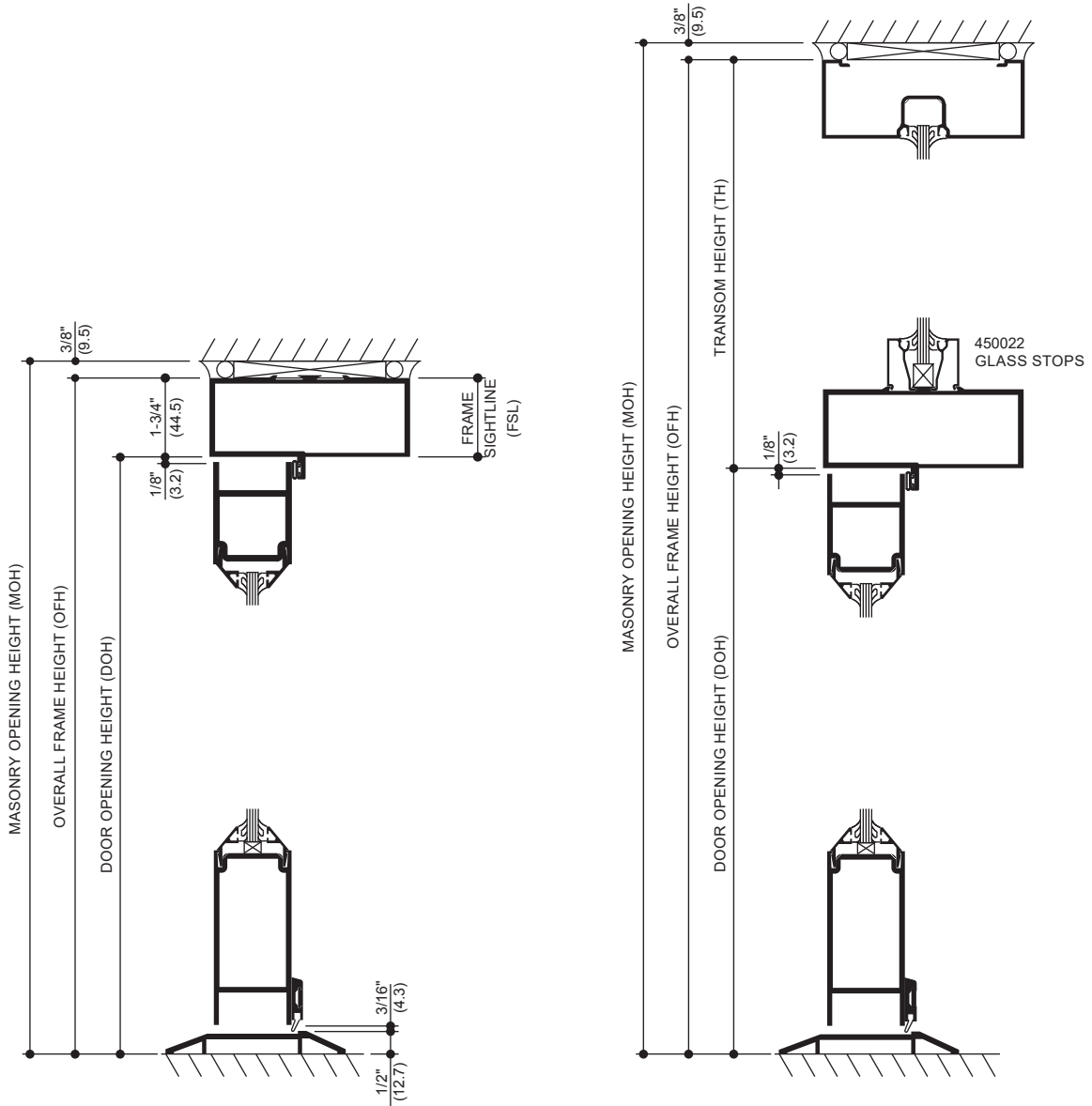

STANDARD SIZES (TRIFAB® 400 & TRIFAB® VG 450 CENTER FRAMES)

WITHOUT TRANSOM

Door Opening Dimension (DOH)	Overall Frame Dimension (OFH)	Masonry Opening Dimension (MOH)
7' 0" (2,134)	7' 1-3/4" (2,178)	7' 2-1/8" (2,188)
7' 0" (2,134)	7' 1-3/4" (2,178)	7' 2-1/8" (2,188)
7' 0" (2,134)	7' 1-3/4" (2,178)	7' 2-1/8" (2,188)

STANDARD SIZES (TRIFAB® VG 451 CENTER FRAMES)

WITHOUT TRANSOM

Door Opening Dimension (DOH)	Overall Frame Dimension (OFH)	Masonry Opening Dimension (MOH)
7' 0" (2,134)	7' 2" (2,184)	7' 2-3/8" (2,194)
7' 0" (2,134)	7' 2" (2,184)	7' 2-3/8" (2,194)
7' 0" (2,134)	7' 2" (2,184)	7' 2-3/8" (2,194)

WITHOUT TRANSOM

OFH = DOH + FSL
 MOH = OFH + 3/8"

WITH TRANSOM

OFH = DOH + TH
 MOH = OFH + 3/8"

Note: Dimensions shown above reflect A1 Price Book standard stock door frame height with transom at 10' 3-1/2" (3,137).

Laws and building and safety codes governing the design and use of Kawneer products, such as glazed entrance, window, and curtain wall products, vary widely. Kawneer does not control the selection of product configurations, operating hardware, or glazing materials, and assumes no responsibility therefor.

Kawneer reserves the right to change configuration without prior notice when deemed necessary for product improvement.
 © 2015, Kawneer Company, Inc.

	STANDARD	OPTIONAL
Doors	Narrow stile 190 doors prepared for attachment hardware.	Medium stile 350 or wide stile 500.
Door Sizes Std.	Standard sizes shown on pages 10 and 11.	Any size up to 4' 0" x 8' 0" (1,219 x 2,438).
Glass Stops	Beveled glass stops for 1/4" (6.4) or 3/16" (4.0) infill.	Square glass stops for 3/16" (4.0) or 1/4" (6.4) infill. Also 1" (25.4) stops.
Door Frames	Trifab® 400 - 1-3/4" x 4" (44.5 x 101.6) for single glazing. Trifab® VG 450 Center - 1-3/4" x 4-1/2" (44.5 x 114.3) for single glazing or Trifab® VG 451 Center - 2" x 4-1/2" (50.8 x 114.3) for double glazing.	Any Kawneer framing system suitable for door frames may be selected, but manufactured per order.
Push-Pulls	Single Acting: Architects Classic Hardware CO-9 Pull and CP-II Push Bar. Architects Classic Hardware CO-9 Pull and CP Push Bar. Double Acting: Architects Classic Hardware CP Push Bars.	Single Acting: Architects Classic Hardware CO-12 and CP-II push bar. Architects Classic Hardware CO-12 and CP push bar. Architects Classic Hardware CO-9/CO-9 Pulls. Architects Classic Hardware CO-12/CO-12 Pulls. Double Acting: Architects Classic Hardware CO-9/CO-9 Pulls. Architects Classic Hardware CO-12/CO-12 Pulls.
Door Closers	Single Acting: Norton 1601 adjustable or 1601 BF adjustable surface closer with back-check and with or without adjustable hold-open. Standard concealed overhead closer with single acting offset arm. Double Acting: Standard concealed overhead closer with 90 degree or 105 degree hold-open or without hold open. For heavy traffic & high wind applications, a supplemental door stop is recommended.	Single Acting: LCN 4040 surface closer with or without adjustable hold-open. LCN 2030 or 5010 concealed overhead closers with or without hold-open. LCN 1260 adjustable surface closer. Norton 8100 surface closer with a 50% spring power adjustment (for opening forces of less than 8 pounds). Closer is available with standard back-checks and with or without the hold-open feature. International single acting concealed overhead closer. Falcon SC 60 Surface closer. Double Acting: International overhead concealed closer.
Hinging	Single Acting: Kawneer top and bottom offset pivots (or) Kawneer top and bottom 4 1/2" x 4" (114.3 x 101.6) ball bearing butt hinge with non-removable pin (NRP) (or) Kawneer continuous gear hinge. Double Acting: Kawneer bottom center pivots for use with concealed overhead closer.	Double Acting: Kawneer top center (walking beam) pivot for use with floor closers.
Intermediate Pivots/Butts	Single Acting: Kawneer intermediate offset pivot (or) Kawneer 4-1/2" x 4" (114.3 x 101.6) ball bearing butt hinge with non-removable pin (NRP).	Single Acting: Rixson M-19 or IVES #7215-INT intermediate offset pivot.
Power Transfers	Single Acting: Kawneer EL intermediate offset pivot (or) Kawneer EL 4 1/2" x 4" (114.3 x 101.6) ball bearing butt hinge with wire transfer (or) EPT (Electric Power Transfer).	
Power Supply	SP-1000X Power Supply: For use with Paneline® EL exit devices. For use with Falcon EL 1690 and EL 1790 exit devices. SP-2000 Power Supply: For use with Paneline® MEL exit devices.	NP1 Power Supply: For use with Kawneer 1686 MEL and 1786 MEL exit devices only.
Locks - Active Leaf	Adams-Rite MS 1850A deadlock with two 1-5/32" (29.4) diameter 5 pin cylinders.	Adams-Rite #4510 latch lock. Adams-Rite #1850A-500 short throw deadlock. Adams-Rite #1850A-505 hookbolt lock. Adams-Rite #4015 two-point Lock. Adams-Rite #4085 three-point Lock. Adams-Rite #4089 exit indicator. Kawneer cylinder guard. Kawneer thumbturn (in lieu of cylinder).

Laws and building and safety codes governing the design and use of Kawneer products, such as glazed entrance, window, and curtain wall products, vary widely. Kawneer does not control the selection of product configurations, operating hardware, or glazing materials, and assumes no responsibility therefor.

Kawneer reserves the right to change configuration without prior notice when deemed necessary for product improvement.
© 2015, Kawneer Company, Inc.

	STANDARD	OPTIONAL
Locks - Inactive Leaf	One pair of Kawneer flush bolts in the inactive leaf of a pair of doors.	Controller® is a 3-point locking system consisting of a two point locking device in the inactive leaf in lieu of flush bolts, working in conjunction with the MS 1850A deadlock in the active leaf. This combination provides for greater security than possible with flush bolts and complies with the life safety considerations of building codes which prohibit the use of flush bolts.
Thresholds	A 1/2" x 4" (12.7 x 101.6) aluminum mill finish threshold.	A 1/2" x 6-3/4" (12.7 x 171.5) aluminum mill finish threshold.
Weathering	<p>Single Acting: Weathering system in the door and frame consisting of a dense, bulb polymeric material, which remains resilient and retains its weathering ability under temperature extremes. (The system is complete with an optional EPDM blade gasket sweep strip applied to the bottom door rail with concealed fasteners).</p> <p>Double Acting: Pile cloth weathering in the door and frame.</p>	Bottom Door Sweep
Exit Device	<p>Kawneer 1686 Concealed Rod Exit Device with or without a mortised type cylinder.</p> <p>Kawneer 1786 Rim Exit Device is a rim type exit device with or without a rim type cylinder. Pairs of doors require a Kawneer RM-86 removable mullion.</p> <p>Paneline® exit device is a concealed rod exit device applicable to single or pairs of doors. It features an activating panel contained within the door cross rail.</p>	<p>Kawneer 1686 MEL Concealed Rod Exit Device electric modification is available.</p> <p>Kawneer 1786 MEL Rim Exit Device electric modification is available.</p> <p>Kawneer 1686 CD Concealed Rod Exit Device available with cylinder dogging.</p> <p>Kawneer 1786 CD Rim Exit Device available with cylinder dogging.</p> <p>Kawneer 1686 Lever Handle is available for the Kawneer 1686 concealed rod exit device.</p> <p>Kawneer 1786 Lever Handle is available for the Kawneer 1786 rim type exit device.</p> <p>Falcon 1690 Concealed Rod Exit Device with or without a mortised type cylinder.</p> <p>Falcon 1790 Rim Exit Device is a rim type exit device with or without a rim type cylinder.</p> <p>Falcon EL 1690 electric modification is also available.</p> <p>Falcon EL 1790 electric modification is also available</p> <p>Paneline® MEL electric modification is also available.</p> <p>Falcon 1990 is a concealed rod exit device with or without a rim type cylinder.</p> <p>Falcon 2090 is a rim type exit device with or without a rim type cylinder. Pairs of doors require a removable aluminum mullion. RM-70 with the Falcon 2090 exit device.</p>
	<p>Exit Device Pulls: Architects Classic CO-9 Pull with Kawneer 1686 and 1786 exit devices. Architects Classic CPN Pull for Paneline® and Paneline® MEL exit devices.</p>	<p>Optional Exit Device Pulls: Architects Classic CO-12 Pull with Kawneer 1686 and 1786 exit devices.</p>

APPLICATION CRITERIA

As indicated on Page 10, the standard sizes of swing doors are 3' 0" x 7' 0" (914.4 x 2,133.6) or 3' 6" x 7' 0" (1,067 x 2,134) for single doors and 6' 0" x 7' 0" (1,828.8 x 2,133.6) for pairs of doors. When these sizes are exceeded the following criteria should be administered.

1. Larger doors should not be subject to heavy traffic or strong prevailing wind conditions.
2. Larger doors should use a door closer with a good back check action.
3. When a door exceeds 9' 0" (2,743.2) in height, a cross rail or push bar is recommended to reinforce the vertical stiles.
4. When an offset hung door exceeds 7' 6" (2,286.0) in height, an intermediate butt or offset pivot should be used.
5. Tall doors should be prevented from racking by proper utilization of hardware, including door closers, door holders and door stops.

NOTE:
SOME OF THESE CRITERIA ARE OF A SUBJECTIVE NATURE, CONTACT YOUR FACTORY REPRESENTATIVE FOR APPLICATION ASSISTANCE.

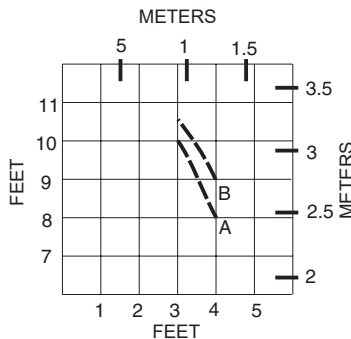

MAXIMUM SIZE DOOR LEAFS GLAZED WITH 1/4" (6.4) GLASS

A = NARROW STILE 190
B = MEDIUM STILE 350 OR WIDE STILE 500
MAXIMUM DOOR HEIGHT FOR PANELINE® MEL = 8' 0"

Laws and building and safety codes governing the design and use of Kawneer products, such as glazed entrance, window, and curtain wall products, vary widely. Kawneer does not control the selection of product configurations, operating hardware, or glazing materials, and assumes no responsibility therefor.

Kawneer reserves the right to change configuration without prior notice when deemed necessary for product improvement.
© 2015, Kawneer Company, Inc.

REFER TO **HARDWARE SECTION** FOR COMPLETE HARDWARE INFORMATION.

ARCHITECTS CLASSIC (PUSH PULL SETS)

SINGLE ACTING DOORS USE A PULL HANDLE AND PUSH BAR AS STANDARD
 DOUBLE ACTING DOORS USE CP PUSH BARS BACK TO BACK AS STANDARD.

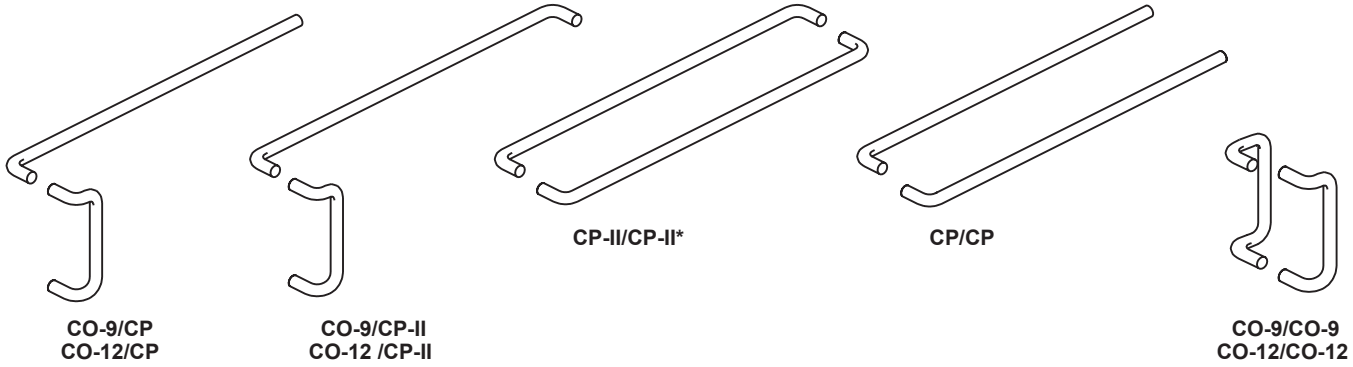

ARCHITECTS CLASSIC (COMPONENTS)

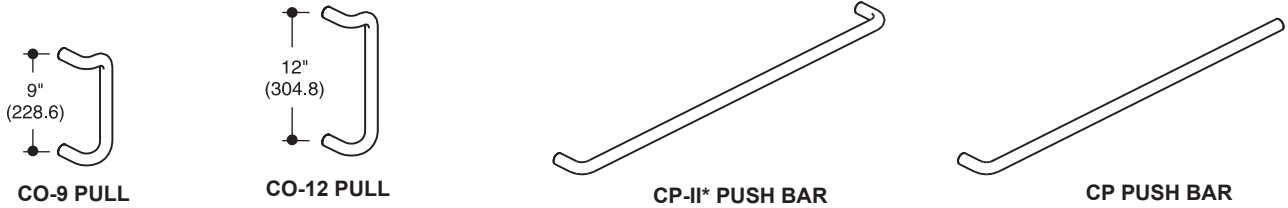

* CP-II PUSH BAR IS NOT TO BE USED FOR BACK TO BACK MOUNTING ON D/A DOORS.

EXIT DEVICES

KAWNEER PANELINE® / PANELINE® MEL

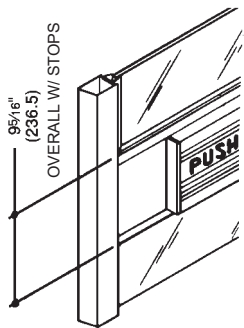

CPN PULL ON EXTERIOR OF DOOR

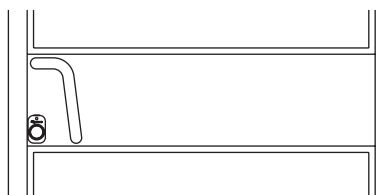

EXTERIOR VIEW OF 190 DOOR (350/500 SIMILAR)
 CPN PULL AND OPTIONAL CYLINDER GUARD SHOWN.

SEE PAGE 15 AND 16 FOR COMPLETE
 PANELINE® INFORMATION

EXIT DEVICES AND PULLS

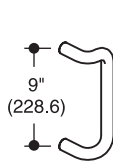

CO-9 PULL

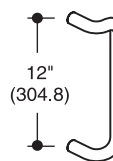

CO-12 PULL

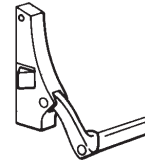

RIM LATCH
 Falcon 2090

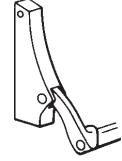

CONCEALED ROD
 Falcon 1990

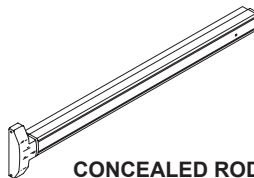

CONCEALED ROD
 Falcon 1690
 Falcon EL 1690

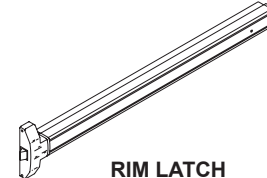

RIM LATCH
 Falcon 1790
 Falcon EL 1790

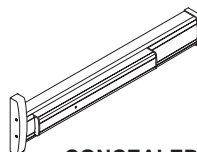

CONCEALED ROD
 Kawneer 1686
 Kawneer 1686 MEL
 Kawneer 1686 CD

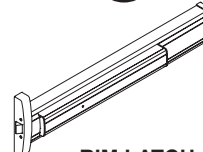

RIM LATCH
 Kawneer 1786
 Kawneer 1786 MEL
 Kawneer 1786 CD

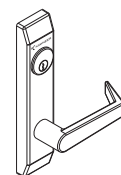

LEVER HANDLE
 Kawneer 1686
 Kawneer 1786

Laws and building and safety codes governing the design and use of Kawneer products, such as glazed entrance, window, and curtain wall products, vary widely. Kawneer does not control the selection of product configurations, operating hardware, or glazing materials, and assumes no responsibility therefor.

Kawneer reserves the right to change configuration without prior notice when deemed necessary for product improvement.
 © 2015, Kawneer Company, Inc.

The Paneline® concealed rod exit device for 190, 350 and 500 doors will accommodate variations in stile width and door width as shown in the following illustrations. Sidelites adjacent to Paneline® equipped doors not requiring exit devices may be fitted with fixed panels as detailed below to match the general appearance of the Paneline® cross rail.



The Optional Paneline® MEL device is designed for electrified access control and is compatible with most key pad and card reader systems.

See **Hardware Section** for complete description of Paneline® hardware, including finish of units.

Paneline® uses mortise cylinder in lieu of the normal rim-type. Dummy Paneline® units are not for use with any type of lock.

INTERIOR ELEVATIONS

NOTE: Sidelites must be stop glazed above and below rail.

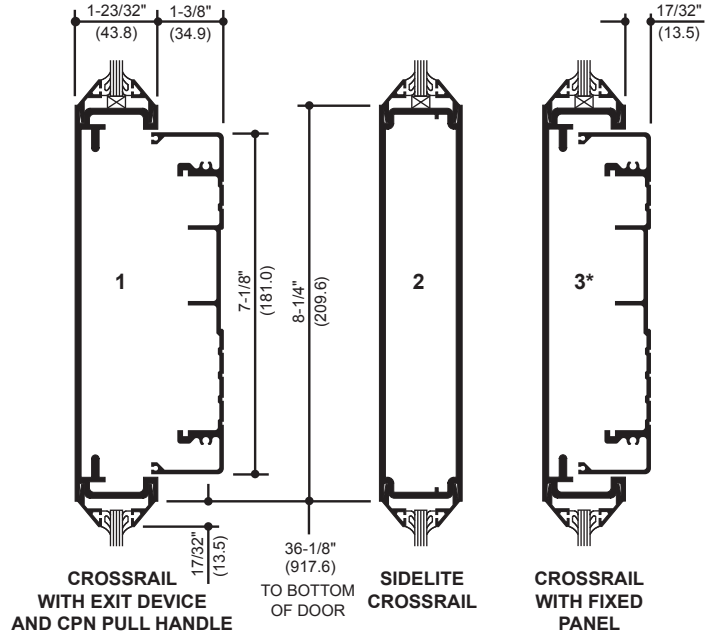
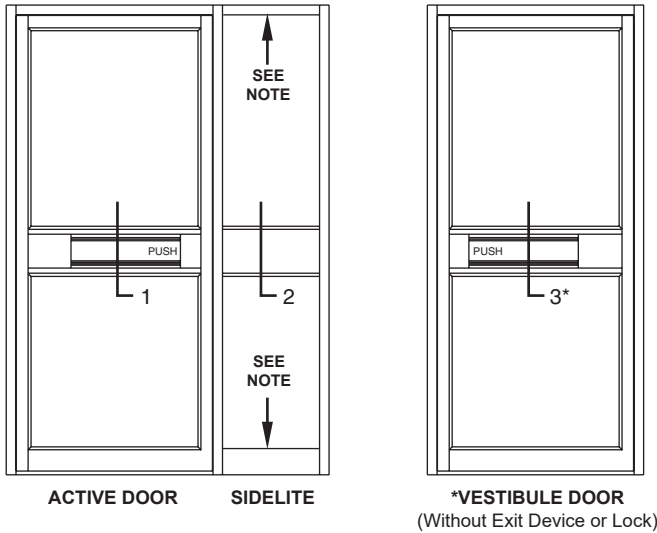

PANELINE® MEL COMPONENTS

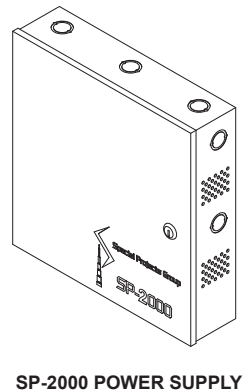
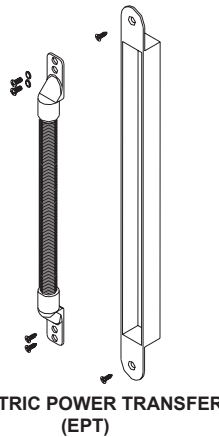
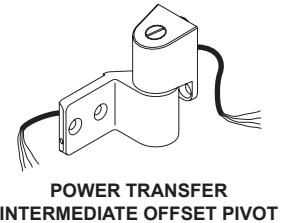
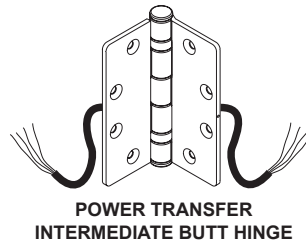
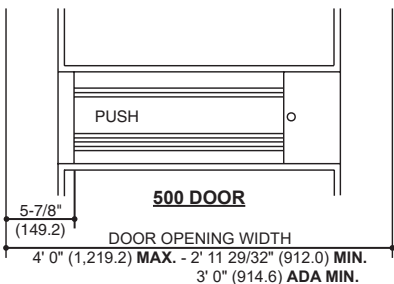
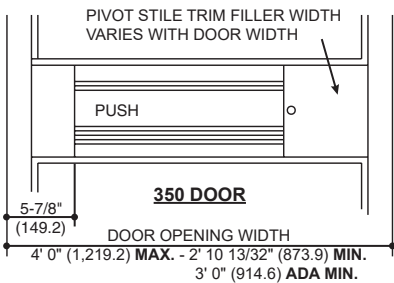
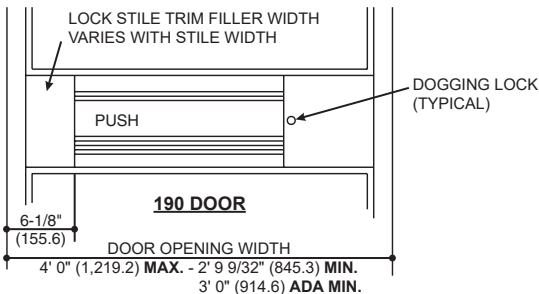

Laws and building and safety codes governing the design and use of Kawneer products, such as glazed entrance, window, and curtain wall products, vary widely. Kawneer does not control the selection of product configurations, operating hardware, or glazing materials, and assumes no responsibility therefor.

Kawneer reserves the right to change configuration without prior notice when deemed necessary for product improvement.
© 2015, Kawneer Company, Inc.

Sidelites adjacent to Paneline® equipped doors not requiring exit devices may be fitted with fixed panels as detailed below to match the general appearance of the Paneline® cross rail.

See **Hardware Section** for complete description of Paneline® hardware, including finish of units.

Paneline® uses mortise cylinder in lieu of the normal rim-type.
 Dummy Paneline® units should not use any type of lock.

INTERIOR ELEVATION

NOTE: Sidelites must be stop glazed above and below rail.

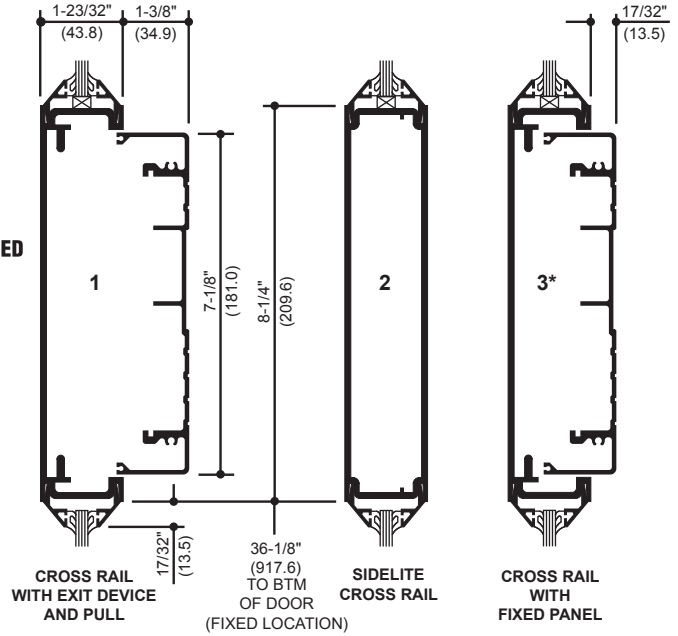
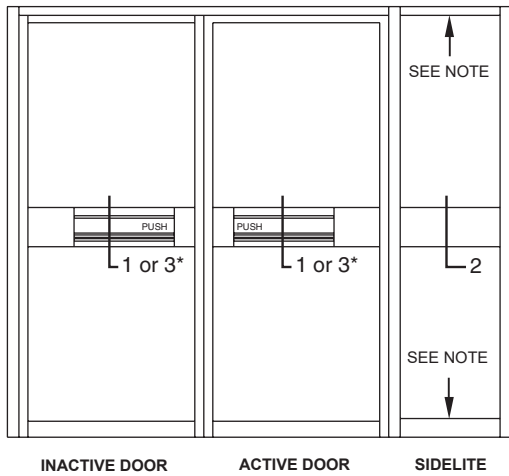

*** ALTERNATE CROSSRAIL FOR VESTIBULE DOORS (Without Exit Device or Lock)**

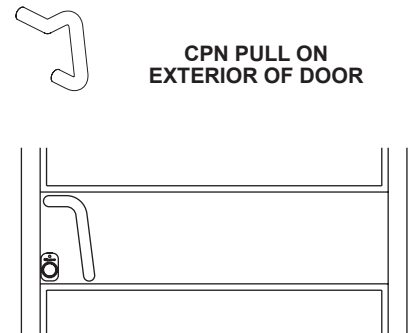
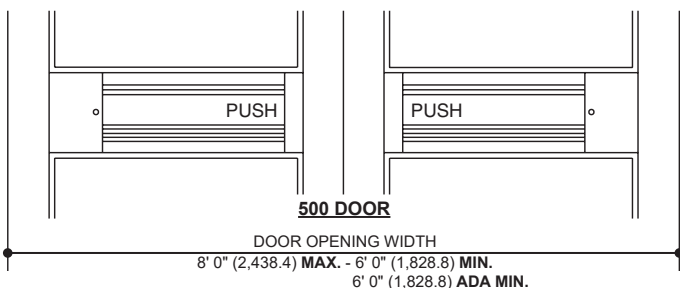
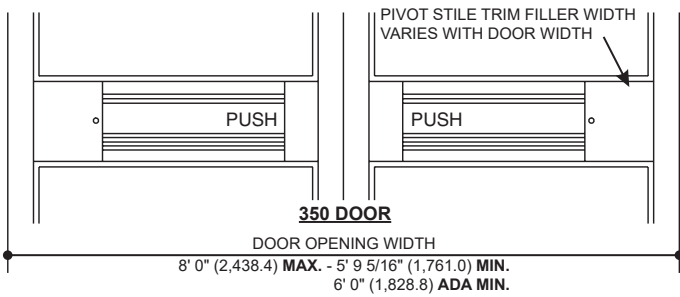
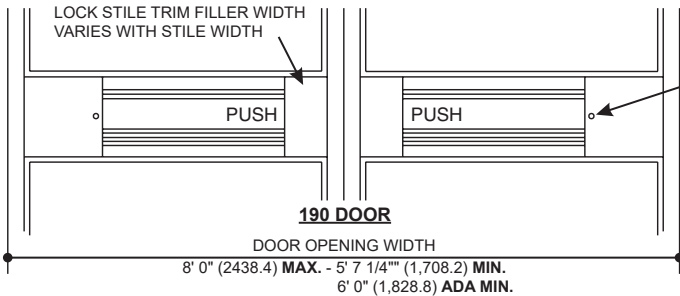

EXTERIOR VIEW OF 190 DOOR (350-500 SIMILAR) WITH CPN PULL AND STANDARD CYLINDER GUARD SHOWN

UL and building and safety codes governing the design and use of Kawneer products, such as glazed entrance, window, and curtain wall products, vary widely. Kawneer does not control the selection of product configurations, operating hardware, or glazing materials, and assumes no responsibility therefor.

Kawneer reserves the right to change configuration without prior notice when deemed necessary for product improvement.
 © 2015, Kawneer Company, Inc.

NOTE: 1/4" GLAZING INFILL ONLY

SWING TYPE

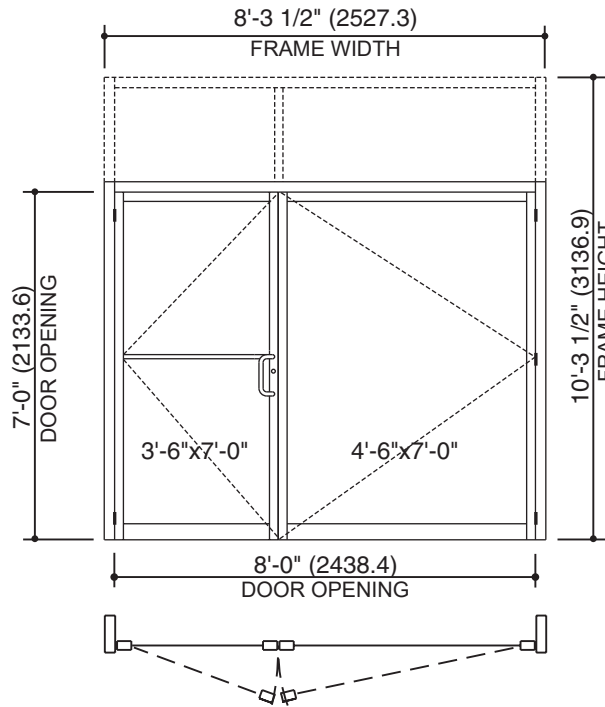

BIFOLD TYPE

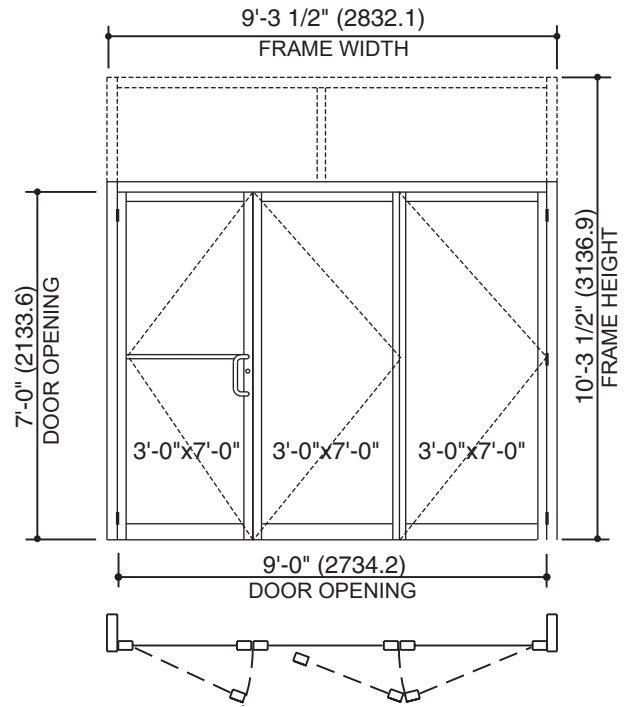

MAXIMUM ALLOWABLE SIZES

- DOOR OPENING WIDTH TO 9' 0" (2,743.2)
- DOOR OPENING HEIGHT TO 8' 0" (2,438.4)
- OVERALL FRAME HEIGHT TO 8' 1 3/4" (2,482.9) W/O TRANSOM
- OVERALL FRAME HEIGHT TO 12' 0" (3,657.6) WITH TRANSOM

AUTO SHOWROOM PACKAGE

DOORS 190 NARROW STILE, 350 MEDIUM STILE AND 500 WIDE STILE DOORS.

FRAME TRIFAB® VERSAGLAZE® 450 CENTER.

CLOSER NORTON 1601 ADJUSTABLE OR 1601 BF ADJUSTABLE SURFACE CLOSER (ACTIVE LEAF ONLY).

BUTT HINGES ONE PAIR 4-1/2" x 4" (114.3 x 101.6) BALL BEARING BUTTS ON ACTIVE LEAF, ONE AND ONE HALF PAIR ON INACTIVE LEAVES AT HINGE JAMB. CONTINUOUS HINGE ON INACTIVE LEAVES.

LOCKS ADAMS-RITE MS1850A WITH (2) CYLINDERS ON ACTIVE LEAF.

FLUSHBOLTS ONE PAIR EDGE MOUNTED FOR INACTIVE LEAVES (FACE MOUNTED ON #2 INACTIVE LEAF OF BIFOLD TYPE).

THRESHOLD 1/2" x 4" (12.7 x 101.6) ALUMINUM.

RISER BLOCK EXTRUDED ALUMINUM BLOCK APPLIED TO BOTTOM RAIL OF EACH INACTIVE LEAF.

OPTIONAL CASTER IN LIEU OF RISER BLOCK, FACE APPLIED CASTER TO LEADING STILE OF INACTIVE LEAF.

Laws and building and safety codes governing the design and use of Kawneer products, such as glazed entrance, window, and curtain wall products, vary widely. Kawneer does not control the selection of product configurations, operating hardware, or glazing materials, and assumes no responsibility therefor.

Kawneer reserves the right to change configuration without prior notice when deemed necessary for product improvement.
© 2015, Kawneer Company, Inc.

Additional information and CAD details are available at www.kawneer.com

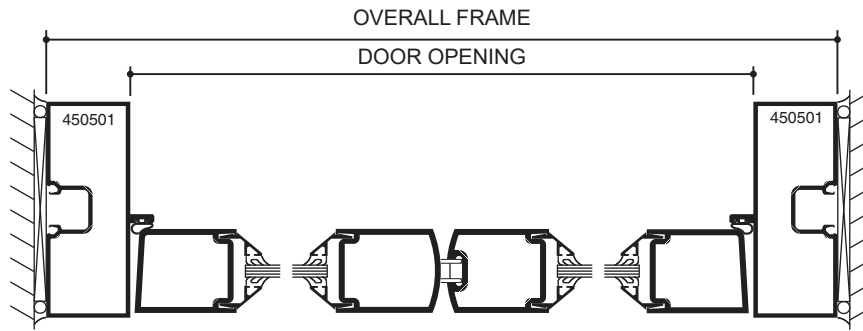

SWING TYPE

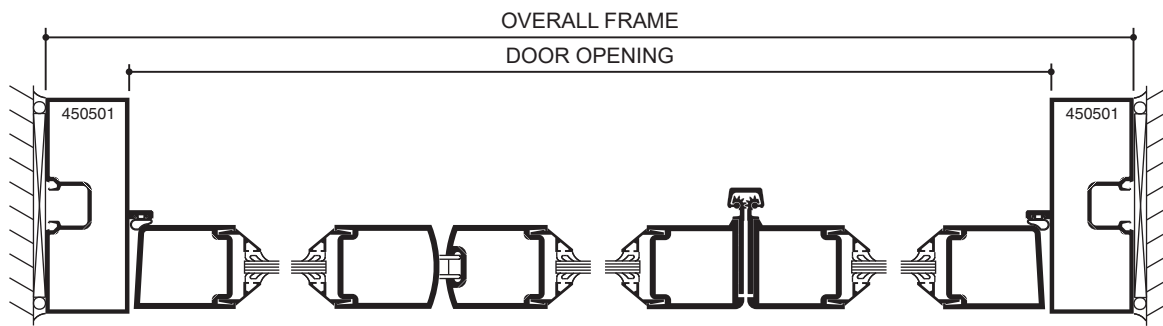

BIFOLD TYPE

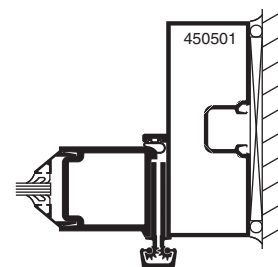

**OPTIONAL
CONTINUOUS HINGE
JAMB**

Laws and building and safety codes governing the design and use of Kawneer products, such as glazed entrance, window, and curtain wall products, vary widely. Kawneer does not control the selection of product configurations, operating hardware, or glazing materials, and assumes no responsibility therefor.

Kawneer reserves the right to change configuration without prior notice when deemed necessary for product improvement.
© 2015, Kawneer Company, Inc.

Additional information and CAD details are available at www.kawneer.com

HORIZONTAL / VERTICAL CROSS RAILS

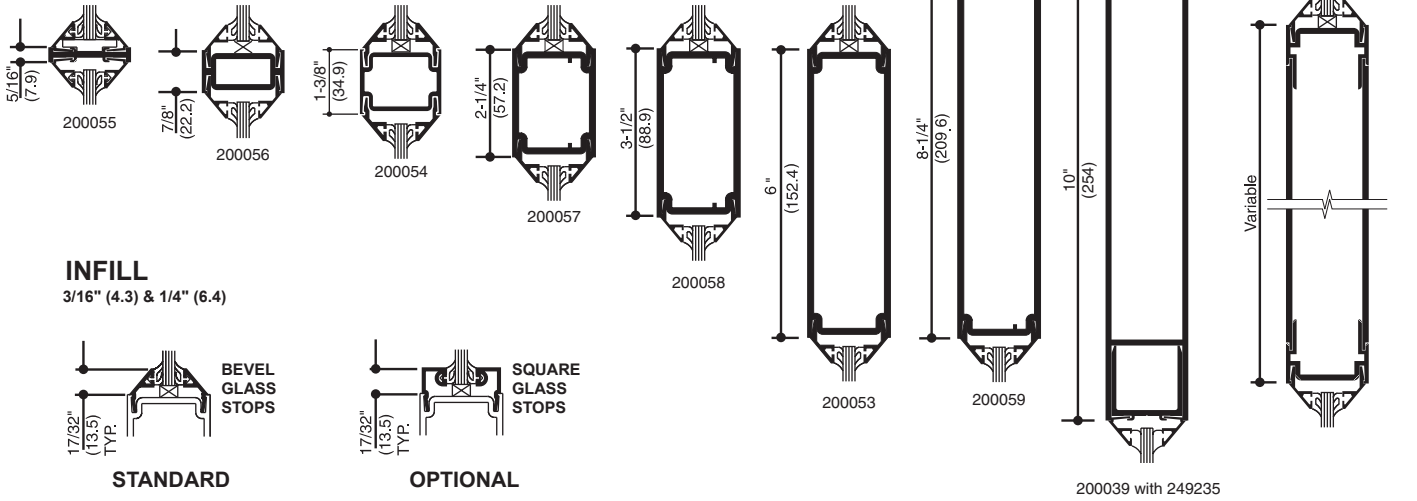

INFILL

3/16" (4.3) & 1/4" (6.4)

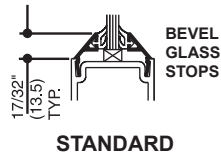

STANDARD

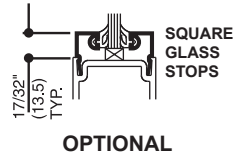

OPTIONAL

INFILL OPTIONS

5/16" (7.9) & 3/8" (9.5)

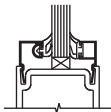

7/16" (11.1) & 1/2" (12.7)

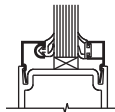

9/16" (14.3) & 5/8" (15.9)

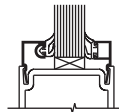

11/16" (17.5) & 3/4" (19.0)

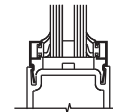

15/16" (23.8) & 1" (25.4)

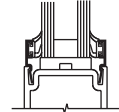

ACCESSORY ITEMS

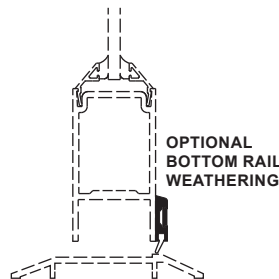
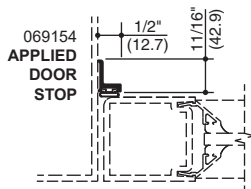
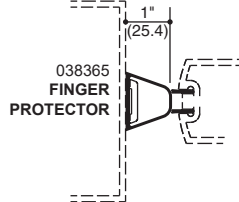
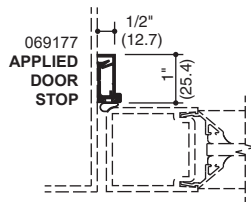

THRESHOLDS

APPLICATION

FOR SINGLE ACTING DOOR

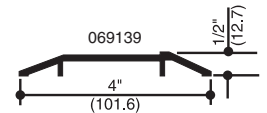

FOR CENTER HUNG CONCEALED CLOSER

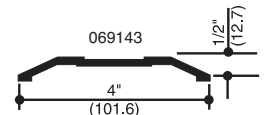

APPLIED STOP FOR SINGLE ACTING DOOR



FOR CENTER HUNG FLOOR CLOSERS

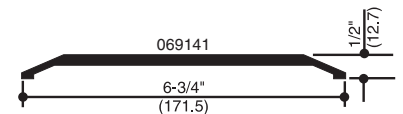

*SOME BUILDING CODES LIMIT THRESHOLD HEIGHT TO 1/2" (12.7) MAX.

Laws and building and safety codes governing the design and use of Kawneer products, such as glazed entrance, window, and curtain wall products, vary widely. Kawneer does not control the selection of product configurations, operating hardware, or glazing materials, and assumes no responsibility therefor.

Kawneer reserves the right to change configuration without prior notice when deemed necessary for product improvement.
© 2015, Kawneer Company, Inc.

PUSH-PULLS

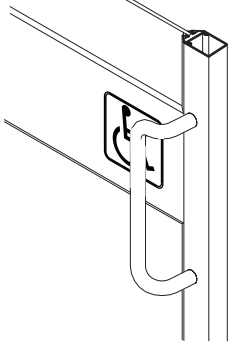
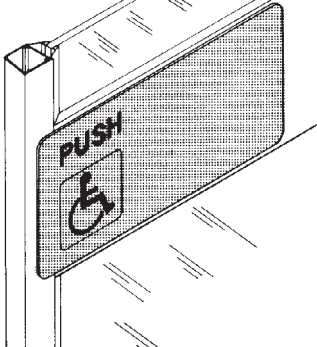
		
Description	Architects Classic CO-12 Pull	BF3 Push Shield with symbol
Application	Door with or without exit device	Door cross rail (omit w/exit device)
Length/Size	12" OC Pull attachment	15-7/8" x 7-7/8" (403.2 x 200.0) 1/8" (3.2) Thick
Height Location	44-5/16" from Top Mounting Hole to Btm. of Door	
Total Projection	3-1/4" (82.6)	1/8" (3.2)
Material / Finish	See Hardware Section	Black Plastic Pebble Finish

Note: The symbol of access is an adhesive backed decal applied to the surface of the optional cross rail. Letters and symbols on plastic push shield are engraved and filled with white epoxy enamel.

Laws and building and safety codes governing the design and use of Kawneer products, such as glazed entrance, window, and curtain wall products, vary widely. Kawneer does not control the selection of product configurations, operating hardware, or glazing materials, and assumes no responsibility therefor.

Kawneer reserves the right to change configuration without prior notice when deemed necessary for product improvement.
© 2015, Kawneer Company, Inc.

Additional information and CAD details are available at www.kawneer.com

STANDARD BOTTOM RAILS

Rail heights shown may be used on 190, 350, and 500 doors.

NOTE:

See Page 19 for available Horizontal Intermediate Members.

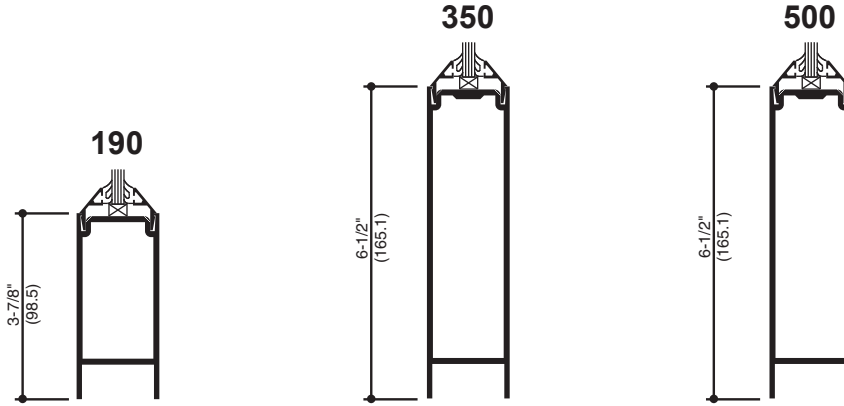

OPTIONAL BOTTOM RAILS

Rail heights shown may be used on 190, 350, and 500 doors. Custom heights available.

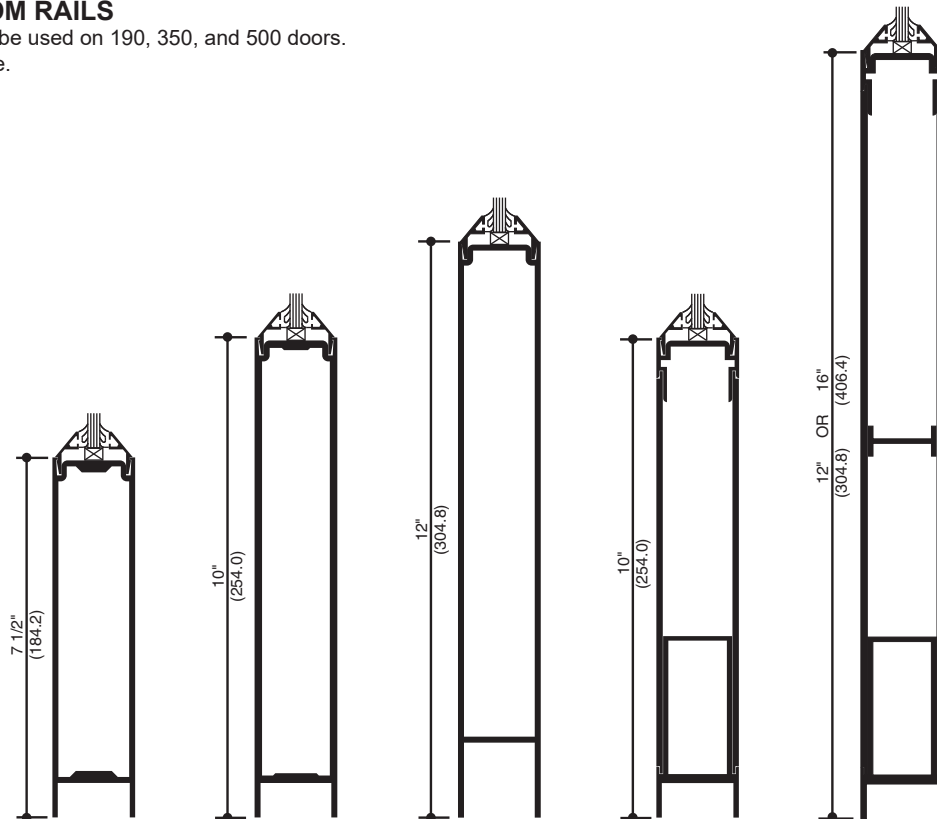

Laws and building and safety codes governing the design and use of Kawneer products, such as glazed entrance, window, and curtain wall products, vary widely. Kawneer does not control the selection of product configurations, operating hardware, or glazing materials, and assumes no responsibility therefor.

Kawneer reserves the right to change configuration without prior notice when deemed necessary for product improvement.
© 2015, Kawneer Company, Inc.

Generic Project Specific U-factor Example Calculation
 (Percent of Glass will vary on specific products depending on sitelines)

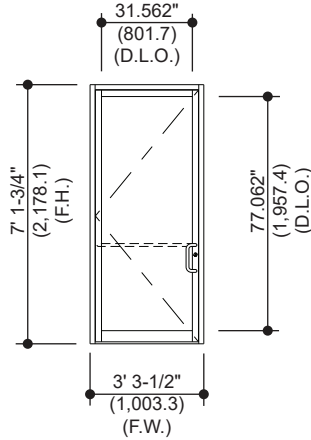

Example Glass U-Factor = 0.28 Btu/hr • ft² • °F

Total Daylight Opening = 31.562" x 77.062" = 16.89 ft²

Total Projected Area = 3' 3-1/2" x 7' 1-3/4" = 23.52 ft²

Percent of Glass = (Total Daylight Opening ÷ Total Projected Area)100
 = (16.89 ÷ 23.52)100 = 72%

System U-factor vs Percent of Glass Area

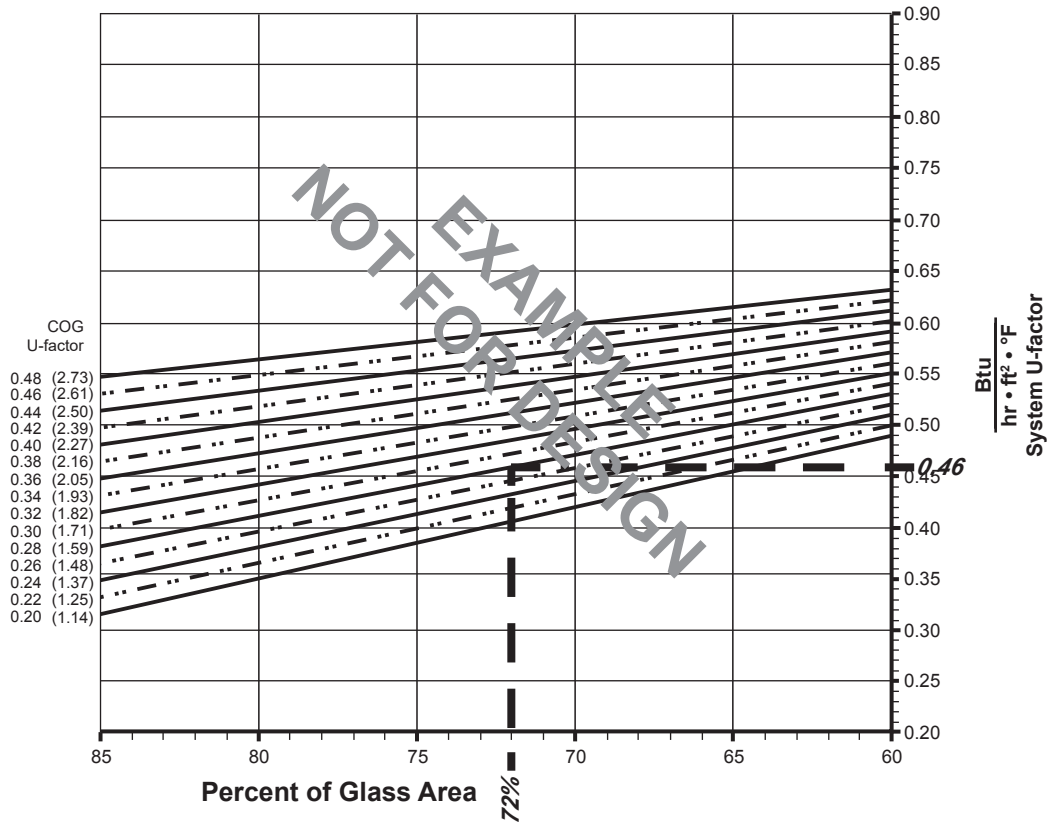

Based on 72% glass and center of glass (COG) U-factor of 0.28
 System U-factor is equal to 0.46 Btu/hr • ft² • °F

Laws and building and safety codes governing the design and use of Kawneer products, such as glazed entrance, window, and curtain wall products, vary widely. Kawneer does not control the selection of product configurations, operating hardware, or glazing materials, and assumes no responsibility therefor.

Kawneer reserves the right to change configuration without prior notice when deemed necessary for product improvement.
 © 2015, Kawneer Company, Inc.

190 (SINGLE DOOR)

System U-factor vs Percent of Glass Area

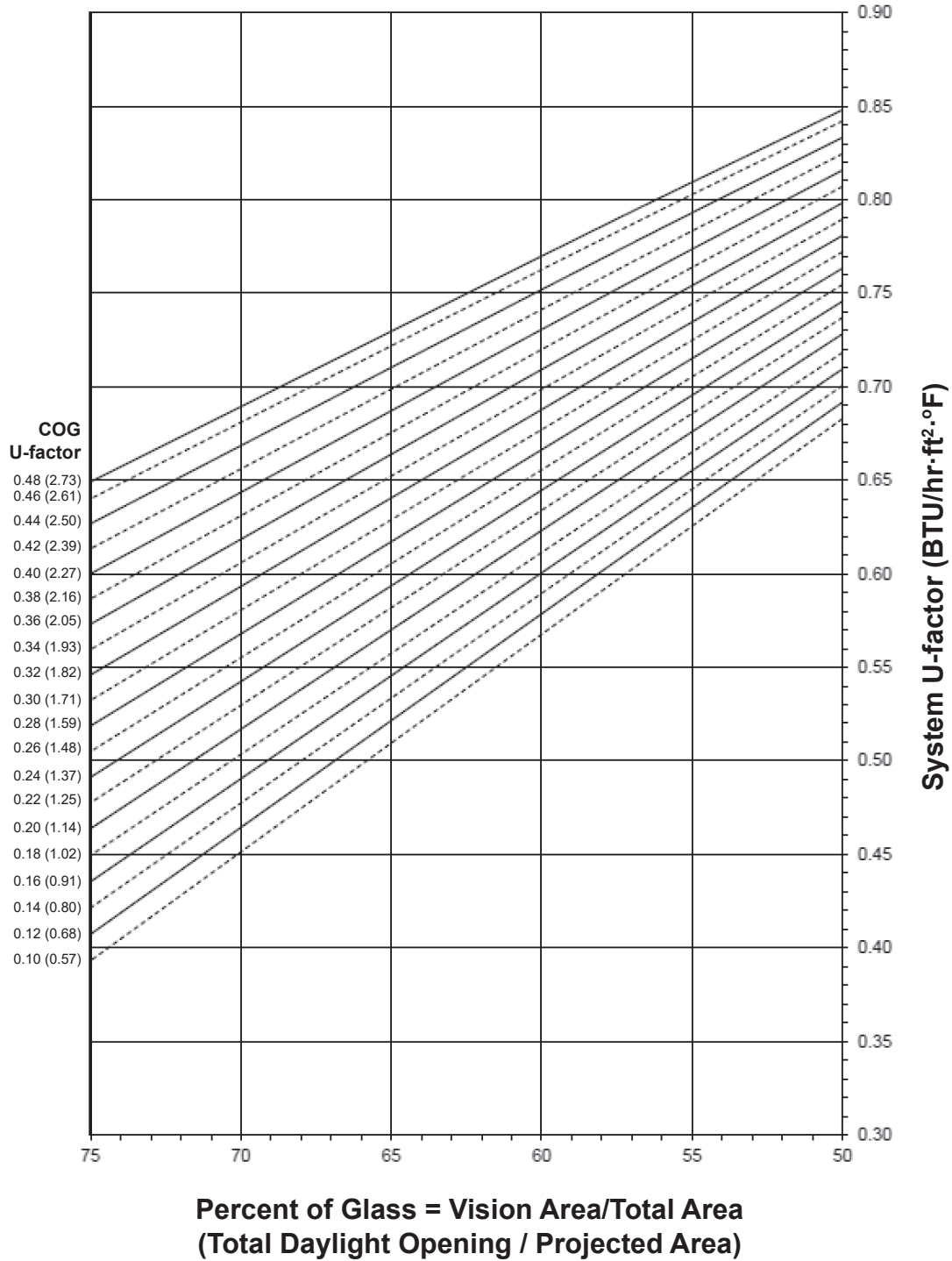

Notes for System U-Factor, SHGC and VT charts:

For glass values that are not listed, linear interpolation is permitted.

Glass properties are based on center of glass values (winter conditions) and are obtained from your glass supplier.

Laws and building and safety codes governing the design and use of Kawneer products, such as glazed entrance, window, and curtain wall products, vary widely. Kawneer does not control the selection of product configurations, operating hardware, or glazing materials, and assumes no responsibility therefor.

Kawneer reserves the right to change configuration without prior notice when deemed necessary for product improvement.
© 2015, Kawneer Company, Inc.

190 (SINGLE DOOR)

System Solar Heat Gain Coefficient (SHGC) vs Percent of Vision Area

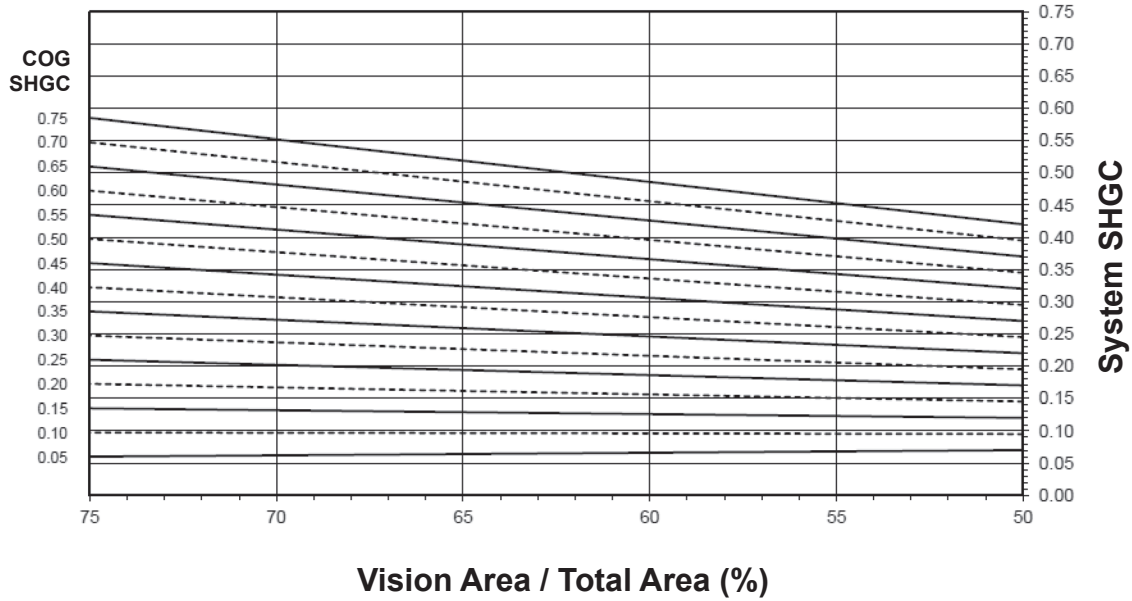

System Visible Transmittance (VT) vs Percent of Vision Area

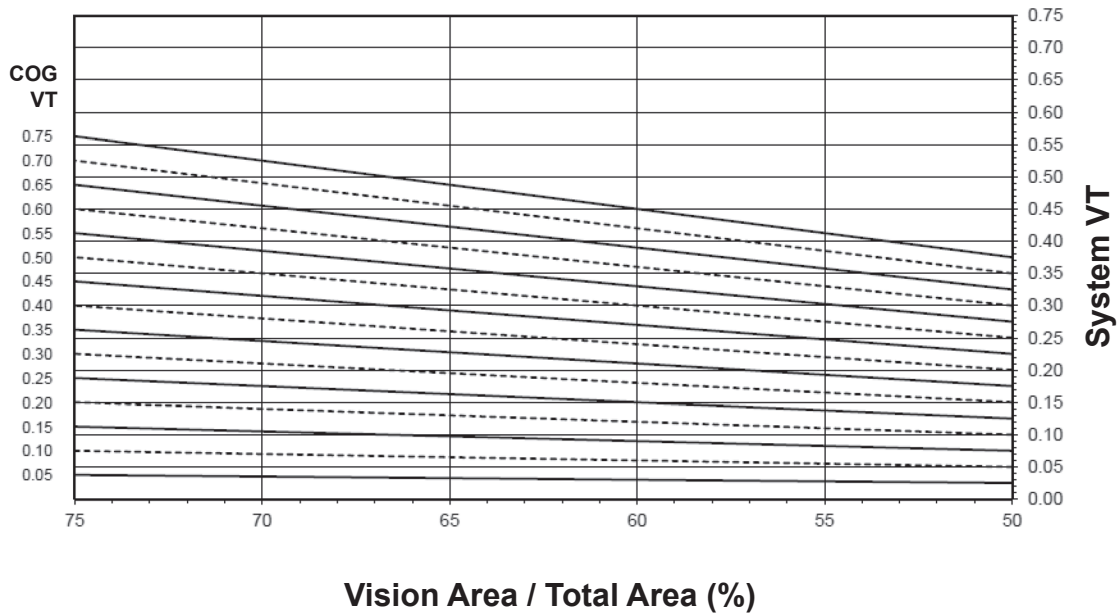

Laws and building and safety codes governing the design and use of Kawneer products, such as glazed entrance, window, and curtain wall products, vary widely. Kawneer does not control the selection of product configurations, operating hardware, or glazing materials, and assumes no responsibility therefor.

Kawneer reserves the right to change configuration without prior notice when deemed necessary for product improvement.
© 2015, Kawneer Company, Inc.

Thermal Transmittance ¹ (BTU/hr • ft ² • °F)

190 (SINGLE DOOR)

Glass U-Factor ³	Overall U-Factor ⁴
0.48	0.78
0.46	0.77
0.44	0.76
0.42	0.75
0.40	0.74
0.38	0.73
0.36	0.72
0.34	0.71
0.32	0.70
0.30	0.69
0.28	0.68
0.26	0.67
0.24	0.66
0.22	0.65
0.20	0.65
0.18	0.63
0.16	0.61
0.14	0.60
0.12	0.59
0.10	0.58

NOTE: For glass values that are not listed, linear interpolation is permitted.

1. U-Factors are determined in accordance with NFRC 100.
2. SHGC and VT values are determined in accordance with NFRC 200.
3. Glass properties are based on center of glass values and are obtained from your glass supplier.
4. Overall U-Factor, SHGC, and VT Matricies are based on the standard NFRC specimen size of 960 mm wide by 2,090 mm high (37-3/4" by 82-3/8").

SHGC Matrix ²

Glass SHGC ³	Overall SHGC ⁴
0.75	0.48
0.70	0.45
0.65	0.42
0.60	0.39
0.55	0.36
0.50	0.33
0.45	0.30
0.40	0.27
0.35	0.24
0.30	0.21
0.25	0.18
0.20	0.15
0.15	0.13
0.10	0.10
0.05	0.07

Visible Transmittance ²

Glass VT ³	Overall VT ⁴
0.75	0.44
0.70	0.41
0.65	0.38
0.60	0.35
0.55	0.32
0.50	0.29
0.45	0.26
0.40	0.23
0.35	0.21
0.30	0.18
0.25	0.15
0.20	0.12
0.15	0.09
0.10	0.06
0.05	0.03

Laws and building and safety codes governing the design and use of Kawneer products, such as glazed entrance, window, and curtain wall products, vary widely. Kawneer does not control the selection of product configurations, operating hardware, or glazing materials, and assumes no responsibility therefor.

Kawneer reserves the right to change configuration without prior notice when deemed necessary for product improvement.
© 2015, Kawneer Company, Inc.

190 (PAIR OF DOORS)

System U-factor vs Percent of Glass Area

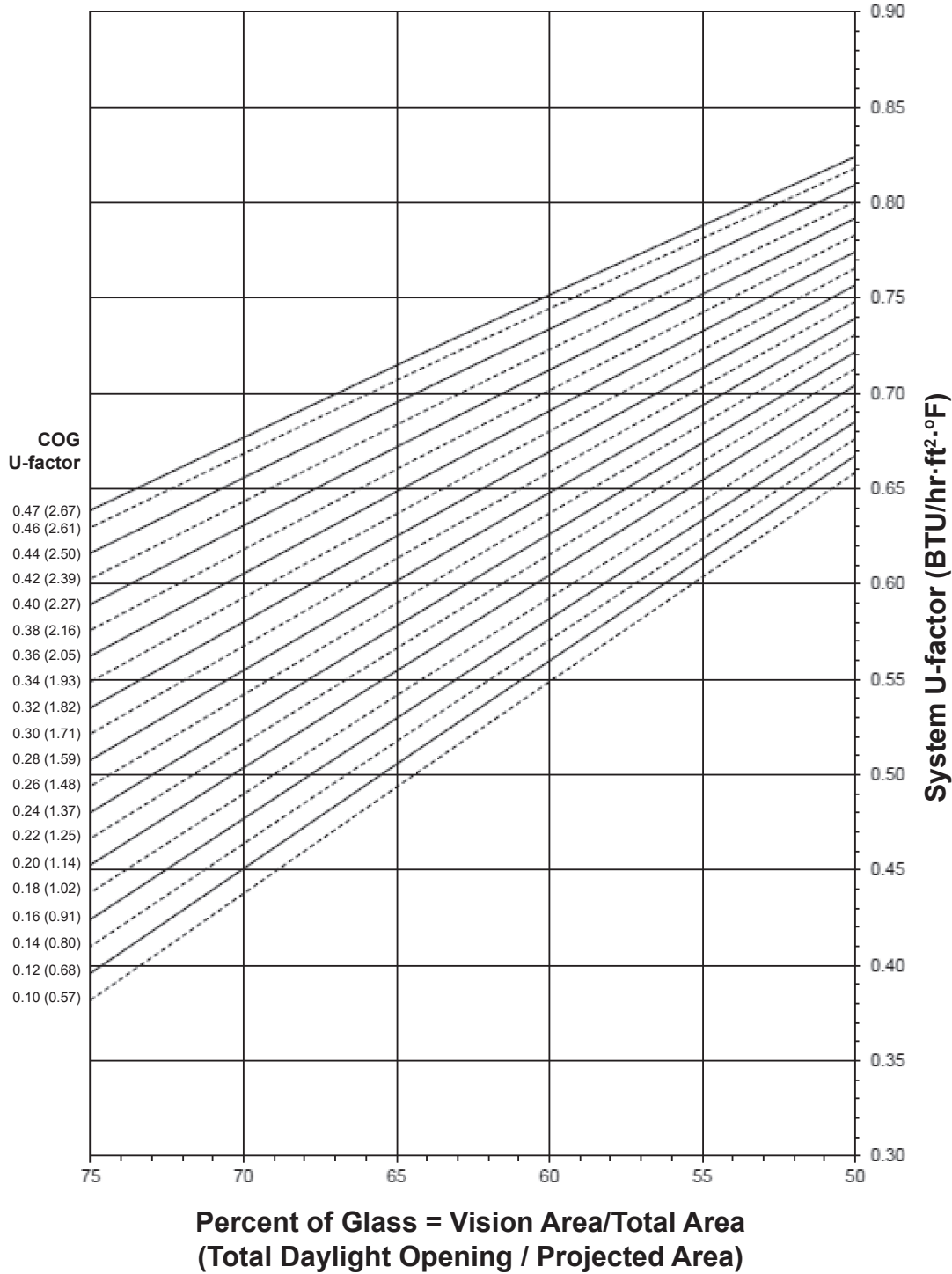

Notes for System U-Factor, SHGC and VT charts:

For glass values that are not listed, linear interpolation is permitted.

Glass properties are based on center of glass values (winter conditions) and are obtained from your glass supplier.

Laws and building and safety codes governing the design and use of Kawneer products, such as glazed entrance, window, and curtain wall products, vary widely. Kawneer does not control the selection of product configurations, operating hardware, or glazing materials, and assumes no responsibility therefor.

Kawneer reserves the right to change configuration without prior notice when deemed necessary for product improvement.
© 2015, Kawneer Company, Inc.

190 (PAIR OF DOORS)

System Solar Heat Gain Coefficient (SHGC) vs Percent of Vision Area

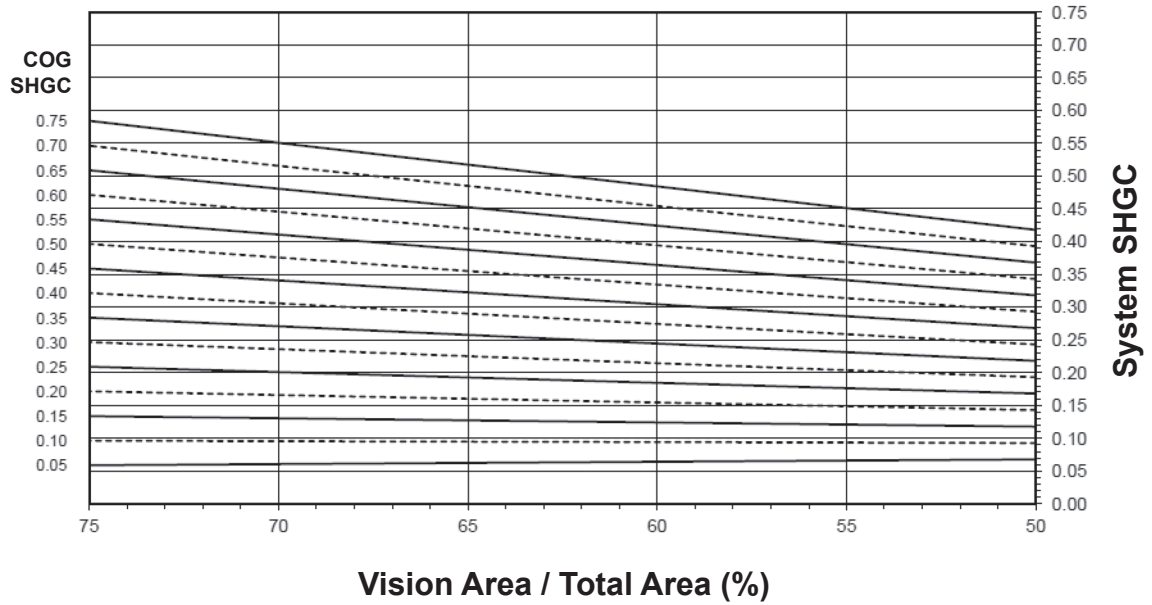

System Visible Transmittance (VT) vs Percent of Vision Area

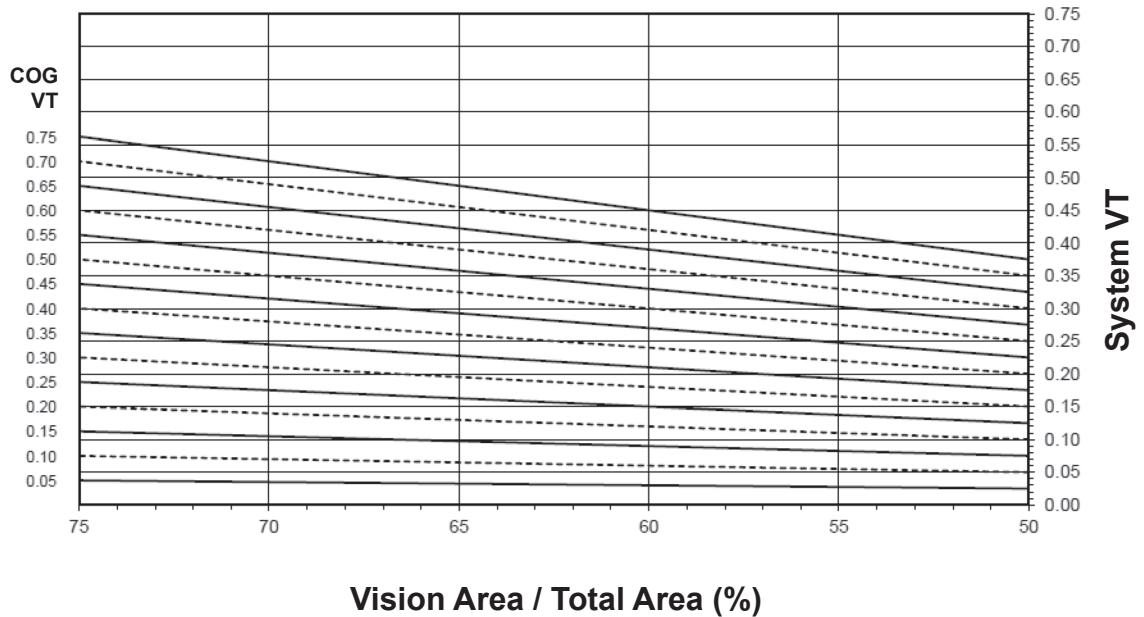

Laws and building and safety codes governing the design and use of Kawneer products, such as glazed entrance, window, and curtain wall products, vary widely. Kawneer does not control the selection of product configurations, operating hardware, or glazing materials, and assumes no responsibility therefor.

Kawneer reserves the right to change configuration without prior notice when deemed necessary for product improvement.
© 2015, Kawneer Company, Inc.

Thermal Transmittance ¹ (BTU/hr • ft² • °F)

Glass U-Factor ³	Overall U-Factor ⁴
0.47	0.73
0.46	0.72
0.44	0.71
0.42	0.70
0.40	0.69
0.38	0.68
0.36	0.67
0.34	0.66
0.32	0.64
0.30	0.63
0.28	0.62
0.26	0.61
0.24	0.60
0.22	0.59
0.20	0.58
0.18	0.56
0.16	0.55
0.14	0.54
0.12	0.53
0.10	0.52

190 (PAIR OF DOORS)

NOTE: For glass values that are not listed, linear interpolation is permitted.

1. U-Factors are determined in accordance with NFRC 100.
2. SHGC and VT values are determined in accordance with NFRC 200.
3. Glass properties are based on center of glass values and are obtained from your glass supplier.
4. Overall U-Factor, SHGC, and VT Matricies are based on the standard NFRC specimen size of 1,920 mm wide by 2,090 mm high (75-1/2" by 82-3/8").

SHGC Matrix ²

Glass SHGC ³	Overall SHGC ⁴
0.75	0.50
0.70	0.47
0.65	0.44
0.60	0.41
0.55	0.38
0.50	0.35
0.45	0.31
0.40	0.28
0.35	0.25
0.30	0.22
0.25	0.19
0.20	0.16
0.15	0.13
0.10	0.09
0.05	0.06

Visible Transmittance ²

Glass VT ³	Overall VT ⁴
0.75	0.47
0.70	0.44
0.65	0.41
0.60	0.38
0.55	0.35
0.50	0.31
0.45	0.28
0.40	0.25
0.35	0.22
0.30	0.19
0.25	0.16
0.20	0.13
0.15	0.09
0.10	0.06
0.05	0.03

Laws and building and safety codes governing the design and use of Kawneer products, such as glazed entrance, window, and curtain wall products, vary widely. Kawneer does not control the selection of product configurations, operating hardware, or glazing materials, and assumes no responsibility therefor.

Kawneer reserves the right to change configuration without prior notice when deemed necessary for product improvement.
© 2015, Kawneer Company, Inc.

350 (SINGLE DOOR)

System U-factor vs Percent of Glass Area

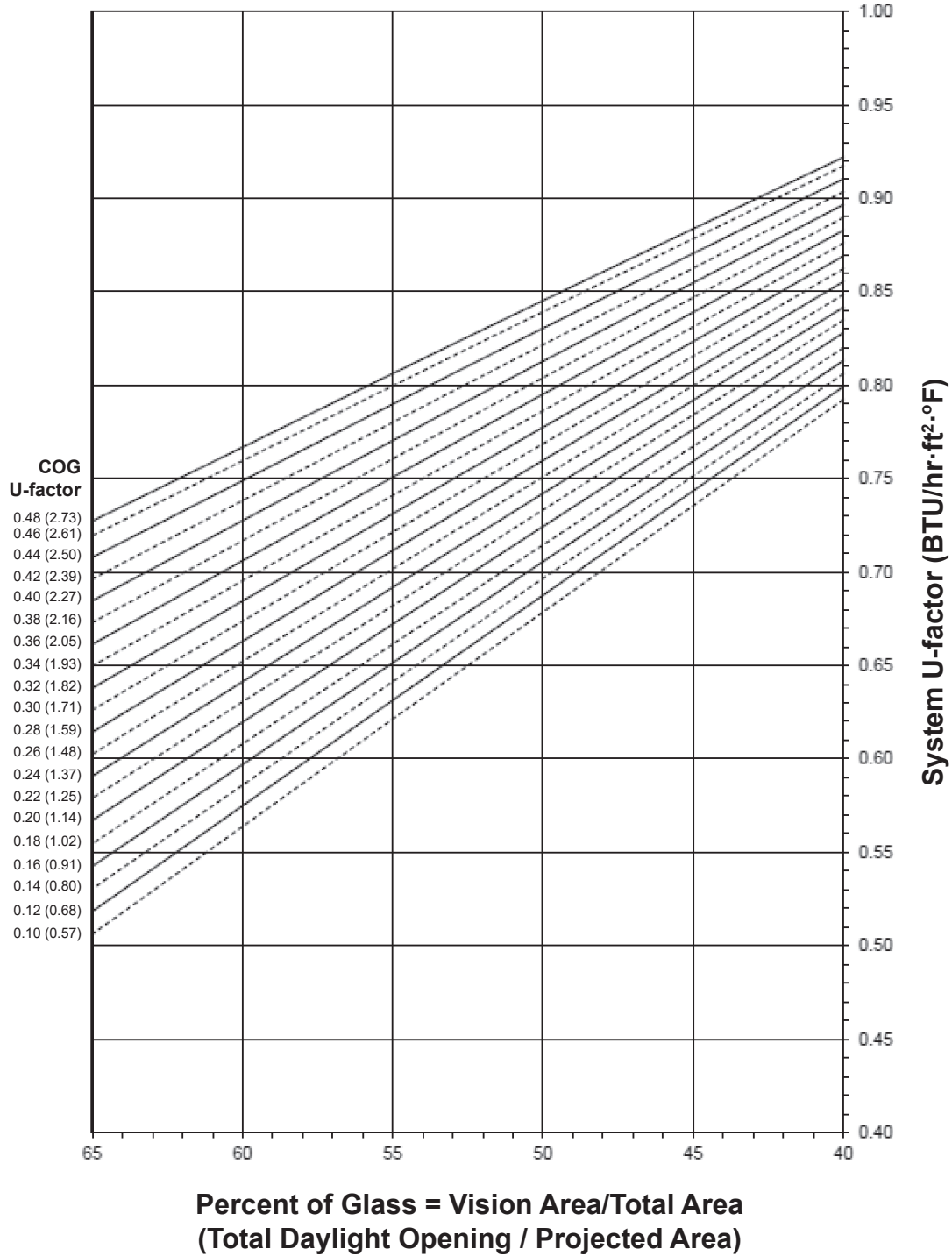

Notes for System U-Factor, SHGC and VT charts:

For glass values that are not listed, linear interpolation is permitted.

Glass properties are based on center of glass values (winter conditions) and are obtained from your glass supplier.

Laws and building and safety codes governing the design and use of Kawneer products, such as glazed entrance, window, and curtain wall products, vary widely. Kawneer does not control the selection of product configurations, operating hardware, or glazing materials, and assumes no responsibility therefor.

Kawneer reserves the right to change configuration without prior notice when deemed necessary for product improvement.
© 2015, Kawneer Company, Inc.

350 (SINGLE DOOR)

System Solar Heat Gain Coefficient (SHGC) vs Percent of Vision Area

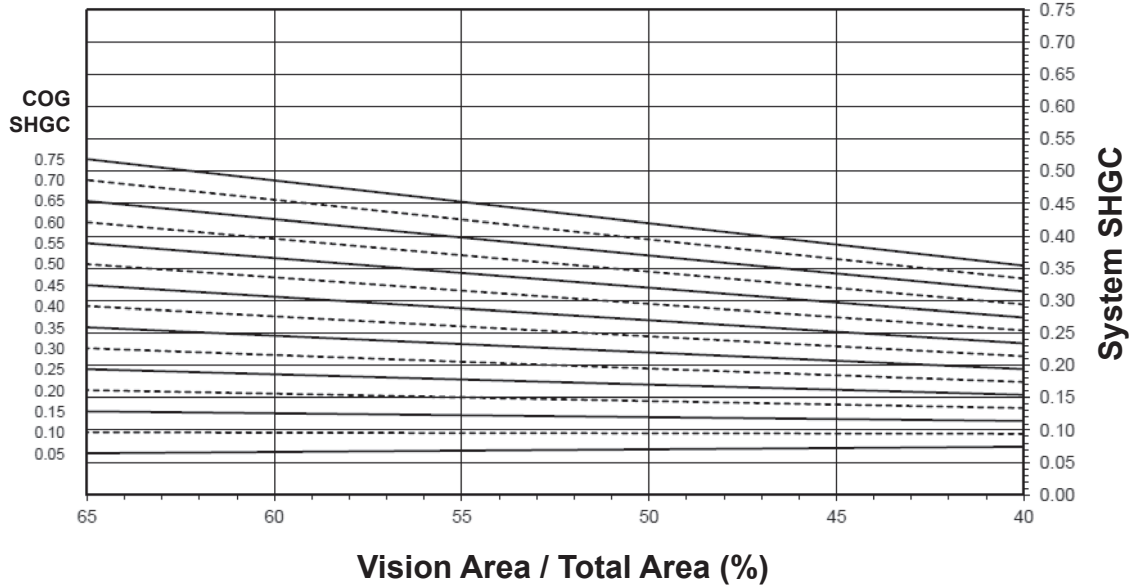

System Visible Transmittance (VT) vs Percent of Vision Area

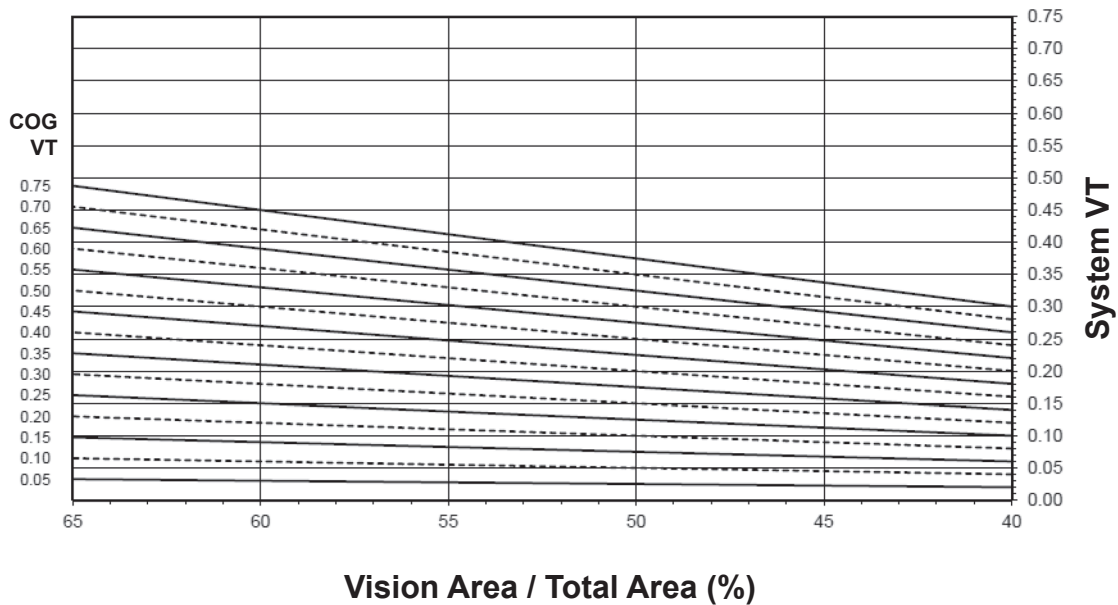

Laws and building and safety codes governing the design and use of Kawneer products, such as glazed entrance, window, and curtain wall products, vary widely. Kawneer does not control the selection of product configurations, operating hardware, or glazing materials, and assumes no responsibility therefor.

Kawneer reserves the right to change configuration without prior notice when deemed necessary for product improvement.
© 2015, Kawneer Company, Inc.

Thermal Transmittance ¹ (BTU/hr • ft ² • °F)

350 (SINGLE DOOR)

Glass U-Factor ³	Overall U-Factor ⁴
0.48	0.83
0.46	0.82
0.44	0.81
0.42	0.81
0.40	0.80
0.38	0.79
0.36	0.78
0.34	0.77
0.32	0.76
0.30	0.75
0.28	0.74
0.26	0.73
0.24	0.72
0.22	0.71
0.20	0.70
0.18	0.69
0.16	0.68
0.14	0.68
0.12	0.67
0.10	0.66

NOTE: For glass values that are not listed, linear interpolation is permitted.

1. U-Factors are determined in accordance with NFRC 100.
2. SHGC and VT values are determined in accordance with NFRC 200.
3. Glass properties are based on center of glass values and are obtained from your glass supplier.
4. Overall U-Factor, SHGC, and VT Matricies are based on the standard NFRC specimen size of 960 mm wide by 2,090 mm high (37-3/4" by 82-3/8").

SHGC Matrix ²

Glass SHGC ³	Overall SHGC ⁴
0.75	0.43
0.70	0.41
0.65	0.38
0.60	0.36
0.55	0.33
0.50	0.30
0.45	0.28
0.40	0.25
0.35	0.23
0.30	0.20
0.25	0.17
0.20	0.15
0.15	0.12
0.10	0.10
0.05	0.07

Visible Transmittance ²

Glass VT ³	Overall VT ⁴
0.75	0.39
0.70	0.36
0.65	0.34
0.60	0.31
0.55	0.29
0.50	0.26
0.45	0.23
0.40	0.21
0.35	0.18
0.30	0.16
0.25	0.13
0.20	0.10
0.15	0.08
0.10	0.05
0.05	0.03

Laws and building and safety codes governing the design and use of Kawneer products, such as glazed entrance, window, and curtain wall products, vary widely. Kawneer does not control the selection of product configurations, operating hardware, or glazing materials, and assumes no responsibility therefor.

Kawneer reserves the right to change configuration without prior notice when deemed necessary for product improvement.
© 2015, Kawneer Company, Inc.

350 (PAIR OF DOORS)

System U-factor vs Percent of Glass Area

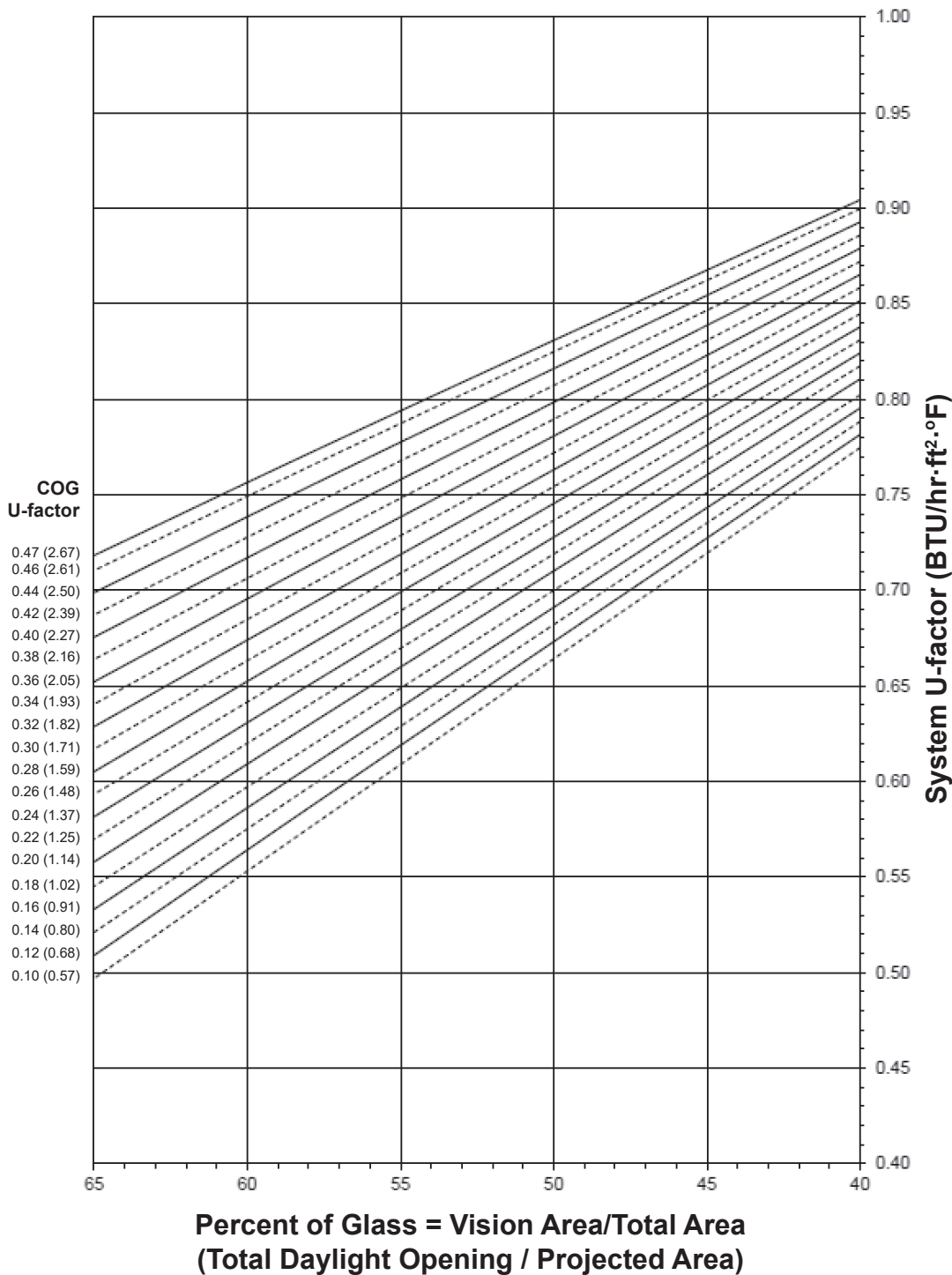

Notes for System U-Factor, SHGC and VT charts:

For glass values that are not listed, linear interpolation is permitted.
 Glass properties are based on center of glass values (winter conditions) and are obtained from your glass supplier.

Laws and building and safety codes governing the design and use of Kawneer products, such as glazed entrance, window, and curtain wall products, vary widely. Kawneer does not control the selection of product configurations, operating hardware, or glazing materials, and assumes no responsibility therefor.

Kawneer reserves the right to change configuration without prior notice when deemed necessary for product improvement.
 © 2015, Kawneer Company, Inc.

350 (PAIR OF DOORS)

System Solar Heat Gain Coefficient (SHGC) vs Percent of Vision Area

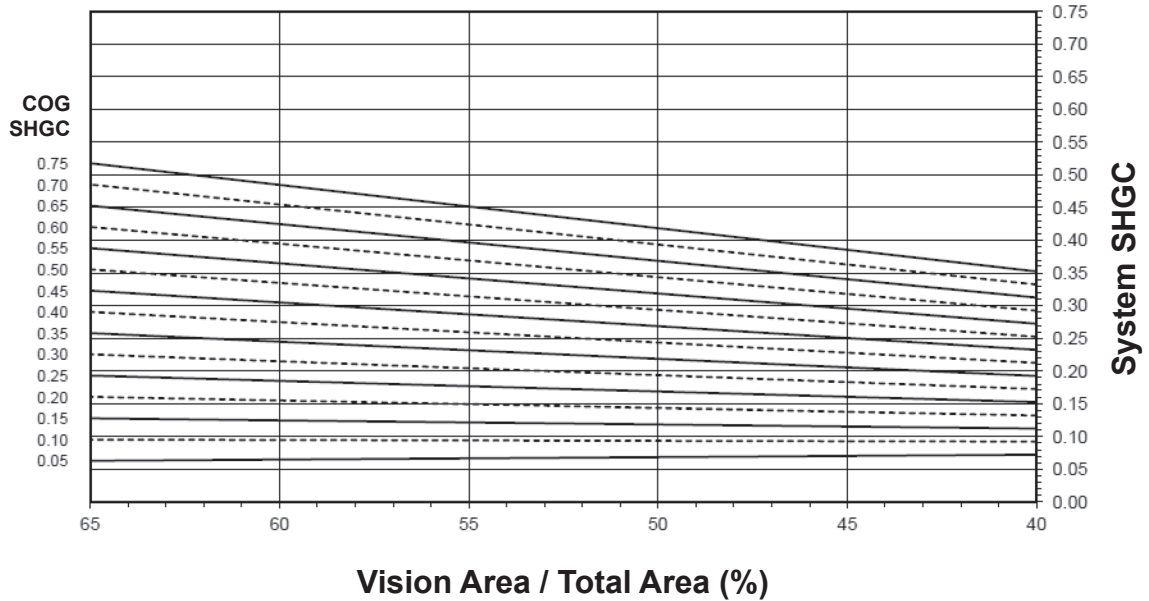

System Visible Transmittance (VT) vs Percent of Vision Area

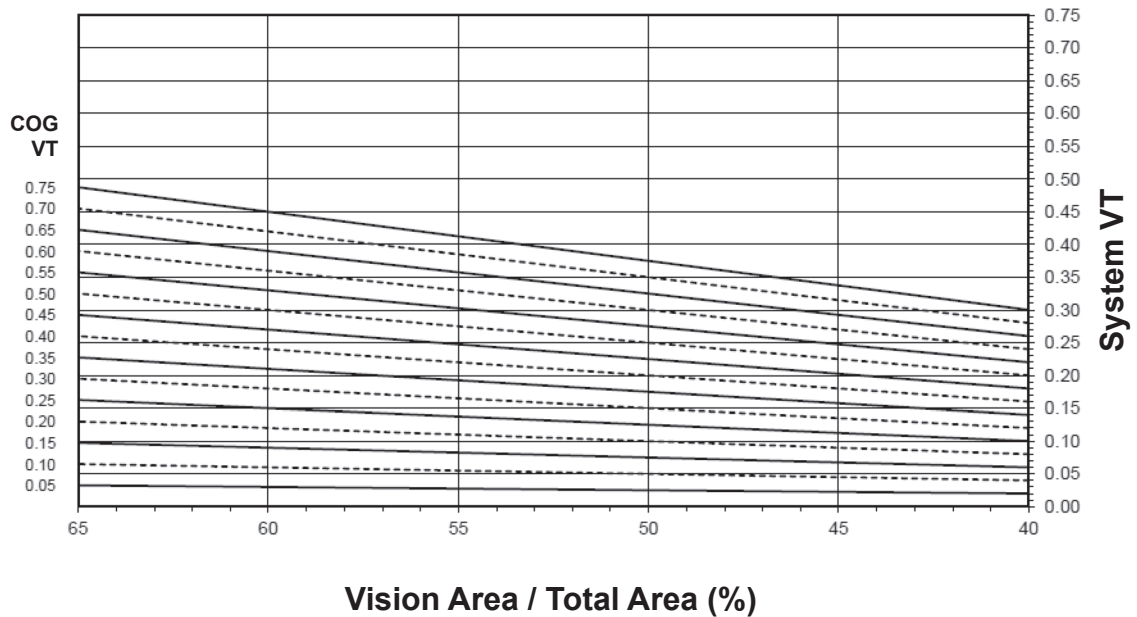

Laws and building and safety codes governing the design and use of Kawneer products, such as glazed entrance, window, and curtain wall products, vary widely. Kawneer does not control the selection of product configurations, operating hardware, or glazing materials, and assumes no responsibility therefor.

Kawneer reserves the right to change configuration without prior notice when deemed necessary for product improvement.
© 2015, Kawneer Company, Inc.

Thermal Transmittance ¹ (BTU/hr • ft² • °F)

Glass U-Factor ³	Overall U-Factor ⁴
0.47	0.79
0.46	0.78
0.44	0.77
0.42	0.76
0.40	0.75
0.38	0.74
0.36	0.73
0.34	0.72
0.32	0.71
0.30	0.70
0.28	0.69
0.26	0.68
0.24	0.67
0.22	0.66
0.20	0.65
0.18	0.64
0.16	0.63
0.14	0.62
0.12	0.61
0.10	0.60

350 (PAIR OF DOORS)

NOTE: For glass values that are not listed, linear interpolation is permitted.

1. U-Factors are determined in accordance with NFRC 100.
2. SHGC and VT values are determined in accordance with NFRC 200.
3. Glass properties are based on center of glass values and are obtained from your glass supplier.
4. Overall U-Factor, SHGC, and VT Matricies are based on the standard NFRC specimen size of 1,920 mm wide by 2,090 mm high (75-1/2" by 82-3/8").

SHGC Matrix ²

Glass SHGC ³	Overall SHGC ⁴
0.75	0.46
0.70	0.43
0.65	0.40
0.60	0.37
0.55	0.35
0.50	0.32
0.45	0.29
0.40	0.26
0.35	0.23
0.30	0.21
0.25	0.18
0.20	0.15
0.15	0.12
0.10	0.09
0.05	0.07

Visible Transmittance ²

Glass VT ³	Overall VT ⁴
0.75	0.42
0.70	0.39
0.65	0.36
0.60	0.34
0.55	0.31
0.50	0.28
0.45	0.25
0.40	0.22
0.35	0.20
0.30	0.17
0.25	0.14
0.20	0.11
0.15	0.08
0.10	0.06
0.05	0.03

Laws and building and safety codes governing the design and use of Kawneer products, such as glazed entrance, window, and curtain wall products, vary widely. Kawneer does not control the selection of product configurations, operating hardware, or glazing materials, and assumes no responsibility therefor.

Kawneer reserves the right to change configuration without prior notice when deemed necessary for product improvement.
© 2015, Kawneer Company, Inc.

500 (SINGLE DOOR)

System U-factor vs Percent of Glass Area

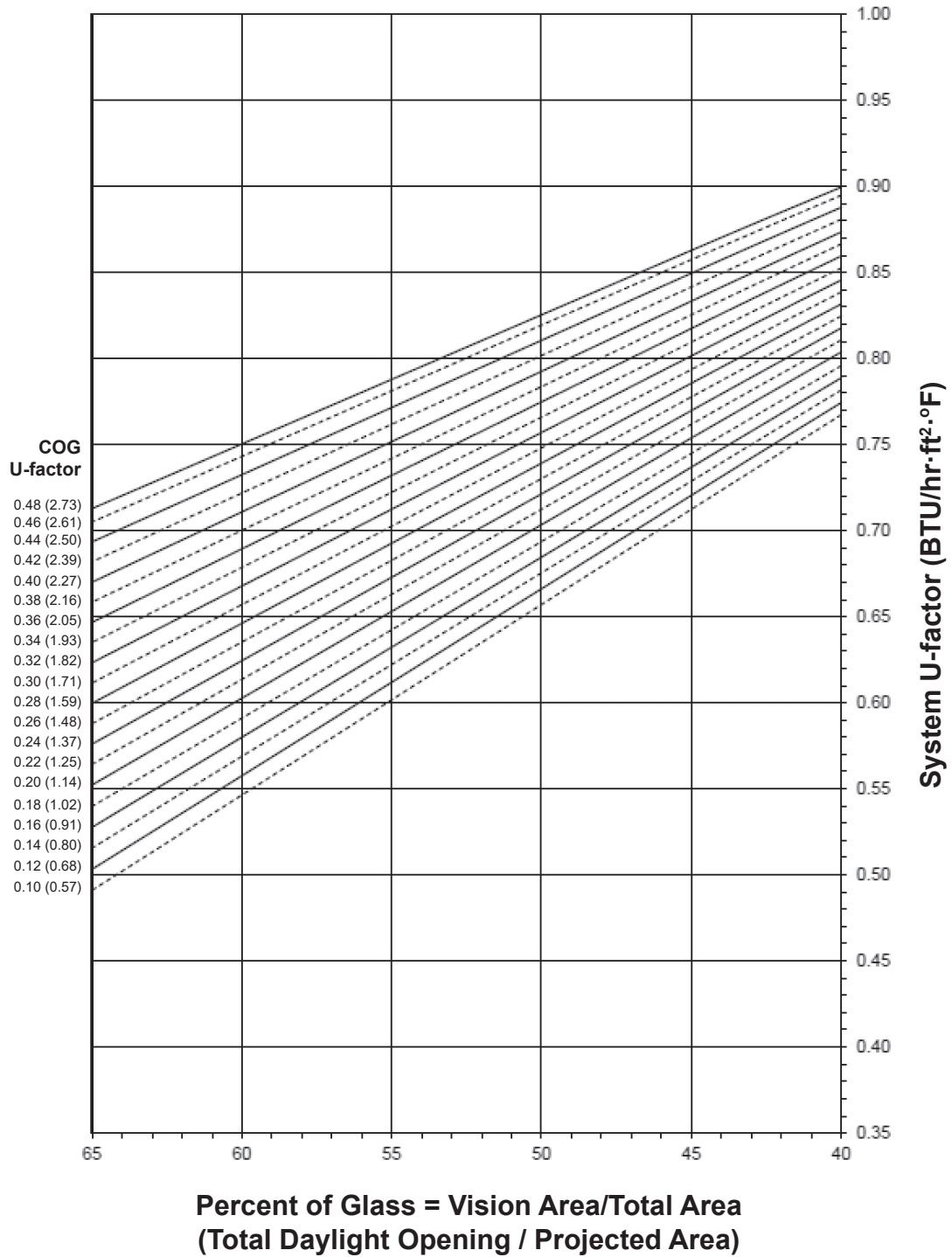

Notes for System U-Factor, SHGC and VT charts:

For glass values that are not listed, linear interpolation is permitted.

Glass properties are based on center of glass values (winter conditions) and are obtained from your glass supplier.

Laws and building and safety codes governing the design and use of Kawneer products, such as glazed entrance, window, and curtain wall products, vary widely. Kawneer does not control the selection of product configurations, operating hardware, or glazing materials, and assumes no responsibility therefor.

Kawneer reserves the right to change configuration without prior notice when deemed necessary for product improvement.
© 2015, Kawneer Company, Inc.

500 (SINGLE DOOR)

System Solar Heat Gain Coefficient (SHGC) vs Percent of Vision Area

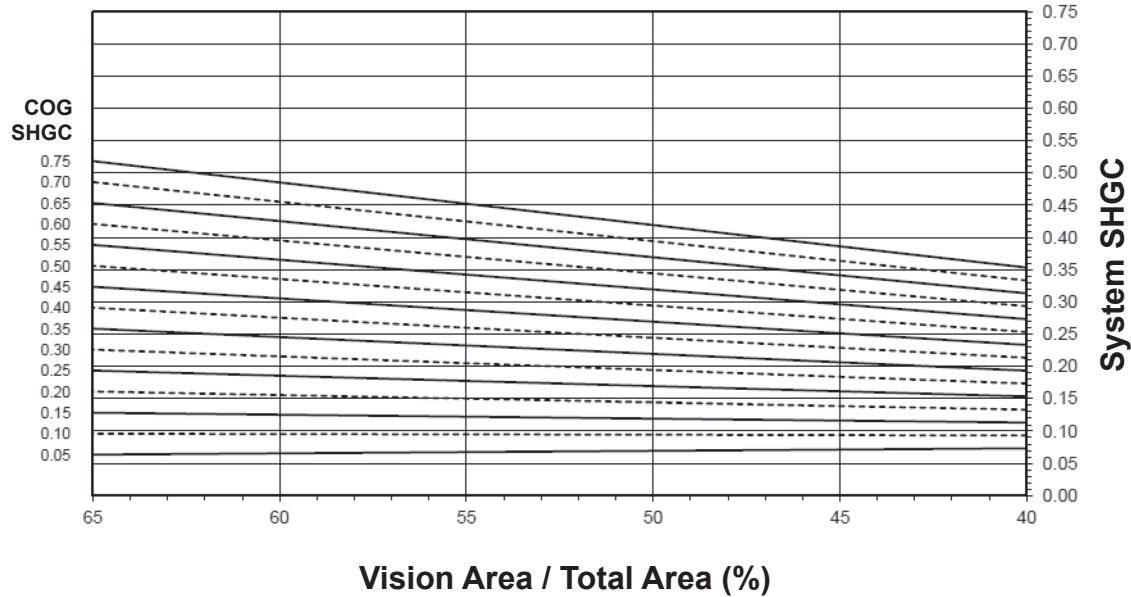

System Visible Transmittance (VT) vs Percent of Vision Area

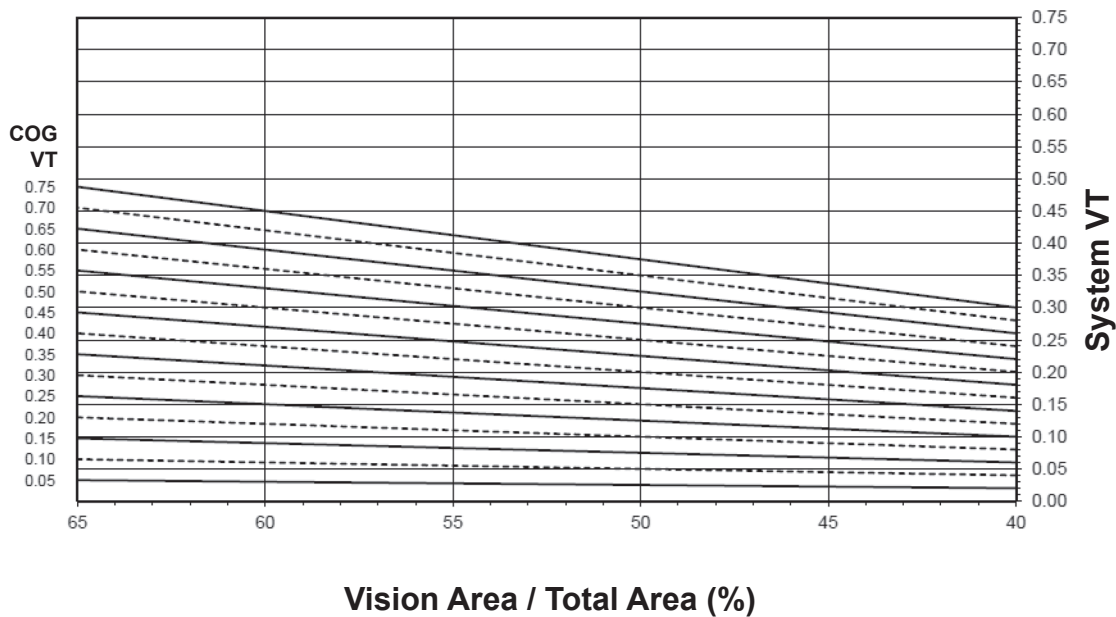

Laws and building and safety codes governing the design and use of Kawneer products, such as glazed entrance, window, and curtain wall products, vary widely. Kawneer does not control the selection of product configurations, operating hardware, or glazing materials, and assumes no responsibility therefor.

Kawneer reserves the right to change configuration without prior notice when deemed necessary for product improvement.
© 2015, Kawneer Company, Inc.

Thermal Transmittance ¹ (BTU/hr • ft ² • °F)

500 (SINGLE DOOR)

Glass U-Factor ³	Overall U-Factor ⁴
0.48	0.87
0.46	0.86
0.44	0.85
0.42	0.84
0.40	0.84
0.38	0.83
0.36	0.82
0.34	0.81
0.32	0.81
0.30	0.80
0.28	0.79
0.26	0.78
0.24	0.77
0.22	0.77
0.20	0.76
0.18	0.75
0.16	0.74
0.14	0.73
0.12	0.73
0.10	0.72

NOTE: For glass values that are not listed, linear interpolation is permitted.

1. U-Factors are determined in accordance with NFRC 100.
2. SHGC and VT values are determined in accordance with NFRC 200.
3. Glass properties are based on center of glass values and are obtained from your glass supplier.
4. Overall U-Factor, SHGC, and VT Matricies are based on the standard NFRC specimen size of 960 mm wide by 2,090 mm high (37-3/4" by 82-3/8").

SHGC Matrix ²

Glass SHGC ³	Overall SHGC ⁴
0.75	0.38
0.70	0.36
0.65	0.34
0.60	0.32
0.55	0.29
0.50	0.27
0.45	0.25
0.40	0.23
0.35	0.21
0.30	0.18
0.25	0.16
0.20	0.14
0.15	0.12
0.10	0.09
0.05	0.07

Visible Transmittance ²

Glass VT ³	Overall VT ⁴
0.75	0.33
0.70	0.31
0.65	0.29
0.60	0.27
0.55	0.25
0.50	0.22
0.45	0.20
0.40	0.18
0.35	0.16
0.30	0.13
0.25	0.11
0.20	0.09
0.15	0.07
0.10	0.04
0.05	0.02

Laws and building and safety codes governing the design and use of Kawneer products, such as glazed entrance, window, and curtain wall products, vary widely. Kawneer does not control the selection of product configurations, operating hardware, or glazing materials, and assumes no responsibility therefor.

Kawneer reserves the right to change configuration without prior notice when deemed necessary for product improvement.
© 2015, Kawneer Company, Inc.

500 (PAIR OF DOORS)

System U-factor vs Percent of Glass Area

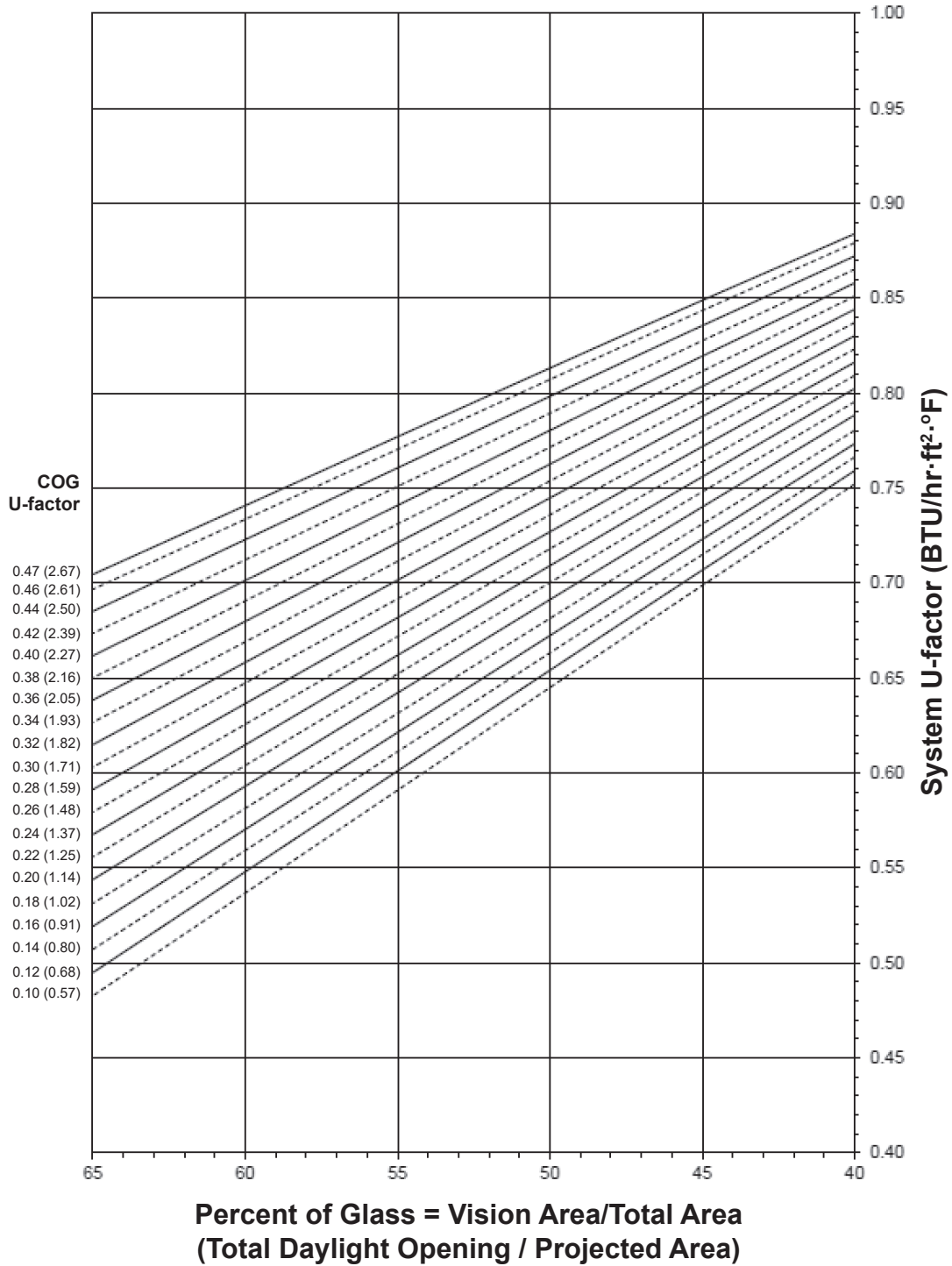

Notes for System U-Factor, SHGC and VT charts:

For glass values that are not listed, linear interpolation is permitted.

Glass properties are based on center of glass values (winter conditions) and are obtained from your glass supplier.

Laws and building and safety codes governing the design and use of Kawneer products, such as glazed entrance, window, and curtain wall products, vary widely. Kawneer does not control the selection of product configurations, operating hardware, or glazing materials, and assumes no responsibility therefor.

Kawneer reserves the right to change configuration without prior notice when deemed necessary for product improvement.
© 2015, Kawneer Company, Inc.

500 (PAIR OF DOORS)

System Solar Heat Gain Coefficient (SHGC) vs Percent of Vision Area

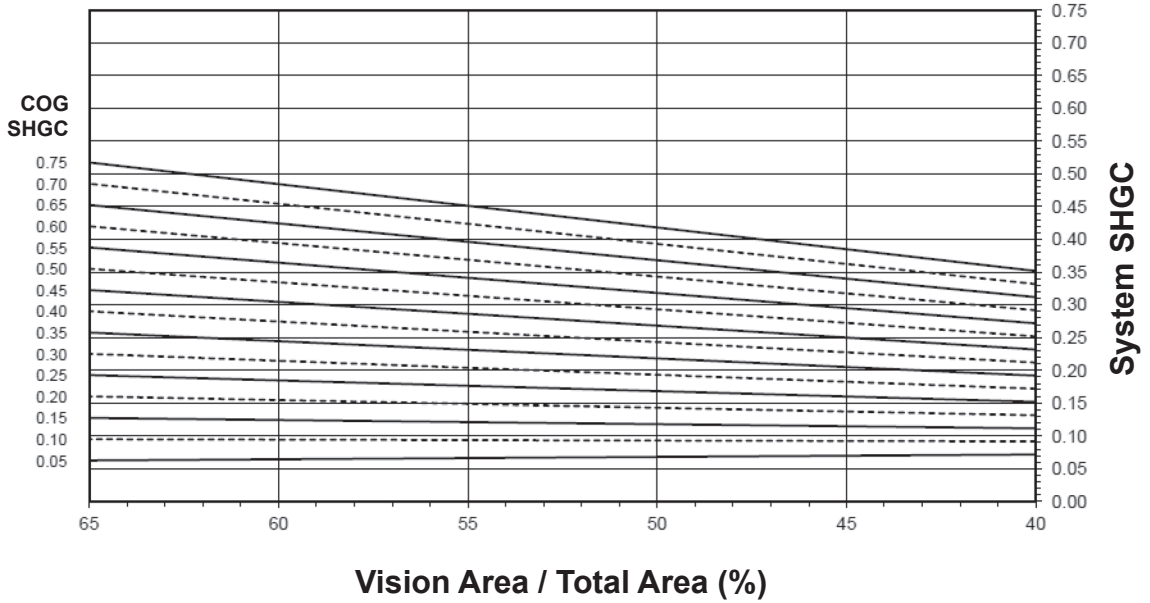

System Visible Transmittance (VT) vs Percent of Vision Area

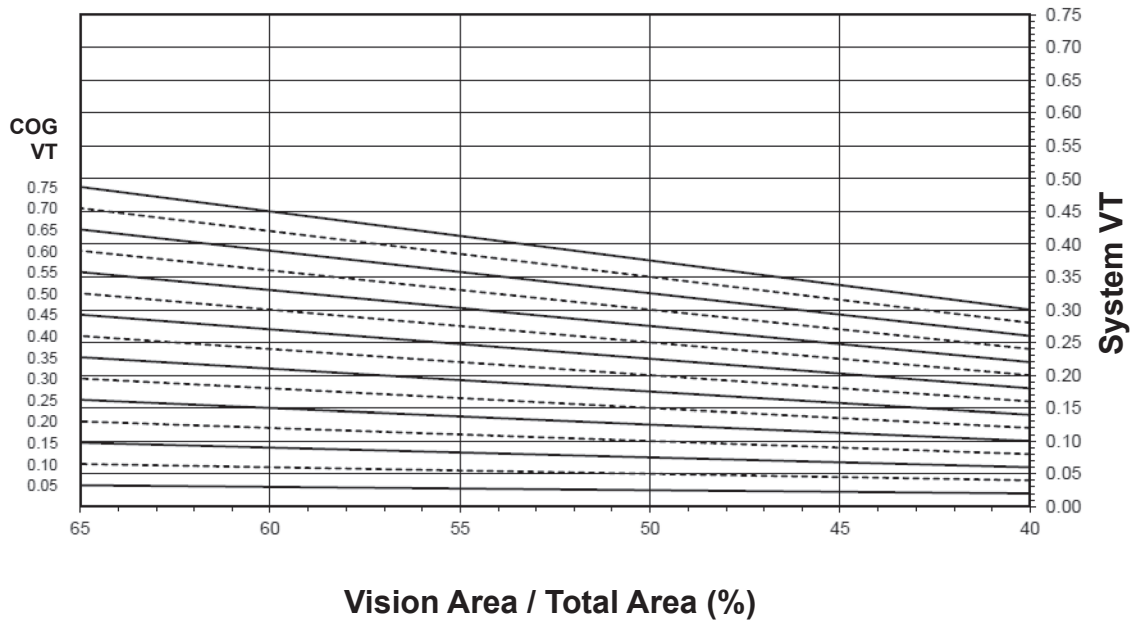

Laws and building and safety codes governing the design and use of Kawneer products, such as glazed entrance, window, and curtain wall products, vary widely. Kawneer does not control the selection of product configurations, operating hardware, or glazing materials, and assumes no responsibility therefor.

Kawneer reserves the right to change configuration without prior notice when deemed necessary for product improvement.
© 2015, Kawneer Company, Inc.

Thermal Transmittance ¹ (BTU/hr • ft² • °F)

Glass U-Factor ³	Overall U-Factor ⁴
0.47	0.82
0.46	0.82
0.44	0.81
0.42	0.80
0.40	0.79
0.38	0.78
0.36	0.77
0.34	0.77
0.32	0.76
0.30	0.75
0.28	0.74
0.26	0.73
0.24	0.72
0.22	0.71
0.20	0.70
0.18	0.70
0.16	0.69
0.14	0.68
0.12	0.67
0.10	0.66

500 (PAIR OF DOORS)

NOTE: For glass values that are not listed, linear interpolation is permitted.

1. U-Factors are determined in accordance with NFRC 100.
2. SHGC and VT values are determined in accordance with NFRC 200.
3. Glass properties are based on center of glass values and are obtained from your glass supplier.
4. Overall U-Factor, SHGC, and VT Matricies are based on the standard NFRC specimen size of 1,920 mm wide by 2,090 mm high (75-1/2" by 82-3/8").

SHGC Matrix ²

Glass SHGC ³	Overall SHGC ⁴
0.75	0.41
0.70	0.38
0.65	0.36
0.60	0.34
0.55	0.31
0.50	0.29
0.45	0.26
0.40	0.24
0.35	0.21
0.30	0.19
0.25	0.17
0.20	0.14
0.15	0.12
0.10	0.09
0.05	0.07

Visible Transmittance ²

Glass VT ³	Overall VT ⁴
0.75	0.36
0.70	0.34
0.65	0.32
0.60	0.29
0.55	0.27
0.50	0.24
0.45	0.22
0.40	0.19
0.35	0.17
0.30	0.15
0.25	0.12
0.20	0.10
0.15	0.07
0.10	0.05
0.05	0.02

Laws and building and safety codes governing the design and use of Kawneer products, such as glazed entrance, window, and curtain wall products, vary widely. Kawneer does not control the selection of product configurations, operating hardware, or glazing materials, and assumes no responsibility therefor.

Kawneer reserves the right to change configuration without prior notice when deemed necessary for product improvement.
© 2015, Kawneer Company, Inc.