

Features

- AA®250 narrow stile has 2-1/2" (63.5) vertical stiles, 2-1/2" (63.5) top rail, and 3-7/8" (98.4) bottom rail
- AA®425 wide stile has 4-1/4" (108) vertical stiles, 4-1/4" (108) top rail, and 6-1/2" (165.1) bottom rail
- Door is 2-1/4" (57.2) deep
- Door has 1/8" (3.2) typical wall thickness
- Dual welded corner construction
- Polyamide thermal break
- Single acting
- 1" (25.4) insulated glass infill
- Offset pivots, butt hinges or continuous geared hinge
- MS locks or exit device hardware
- Surface mounted or concealed closers
- Architects Classic push/pulls
- Meeting stile astragal has dual pile weathering with polymeric fin
- Polymeric bulb weatherstripping and pile weathering with polymeric fin in door frame
- Permanodic® anodized finishes option
- Painted finishes in standard and custom choices

Optional Features

- Variety of top, bottom, and cross rails
- Two color finish capability

Product Applications

- AA®250 - engineered for thermal efficiency in moderate traffic applications such as offices, stores, and apartment buildings
- AA®425 - engineered for thermal efficiency and added strength for schools, institutions and other increased traffic applications

For specific product applications,
consult your Kawneer representative.

Laws and building and safety codes governing the design and use of Kawneer products, such as glazed entrance, window, and curtain wall products, vary widely. Kawneer does not control the selection of product configurations, operating hardware, or glazing materials, and assumes no responsibility therefor.

Kawneer reserves the right to change configuration without prior notice when deemed necessary for product improvement.
© 2015, Kawneer Company, Inc.

Laws and building and safety codes governing the design and use of Kawneer products, such as glazed entrance, window, and curtain wall products, vary widely. Kawneer does not control the selection of product configurations, operating hardware, or glazing materials, and assumes no responsibility therefor.

Kawneer reserves the right to change configuration without prior notice when deemed necessary for product improvement.
© 2015, Kawneer Company, Inc.

PICTORIAL VIEW5

DOOR TYPES/SECTION DIMENSIONS6

AA®250 THERMAL ENTRANCE CONSTRUCTION DETAILS7

TRIFAB® VG 451T CENTER DOOR FRAMES..... 8-9

ENTRANCE OFFERING10-11

PUSH PULL HARDWARE12

EXIT DEVICES13

OPTIONS AND ACCESSORIES14

THERMAL CHARTS 15-27

Metric (SI) conversion figures are included throughout these details for reference. Numbers in parentheses () are millimeters unless otherwise noted.

The following metric (SI) units are found in these details:

- m – meter
- cm – centimeter
- mm – millimeter
- s – second
- Pa – pascal
- MPa – megapascal

Laws and building and safety codes governing the design and use of Kawneer products, such as glazed entrance, window, and curtain wall products, vary widely. Kawneer does not control the selection of product configurations, operating hardware, or glazing materials, and assumes no responsibility therefor.

Kawneer reserves the right to change configuration without prior notice when deemed necessary for product improvement.
© 2015, Kawneer Company, Inc.

Laws and building and safety codes governing the design and use of Kawneer products, such as glazed entrance, window, and curtain wall products, vary widely. Kawneer does not control the selection of product configurations, operating hardware, or glazing materials, and assumes no responsibility therefor.

Kawneer reserves the right to change configuration without prior notice when deemed necessary for product improvement.
© 2015, Kawneer Company, Inc.

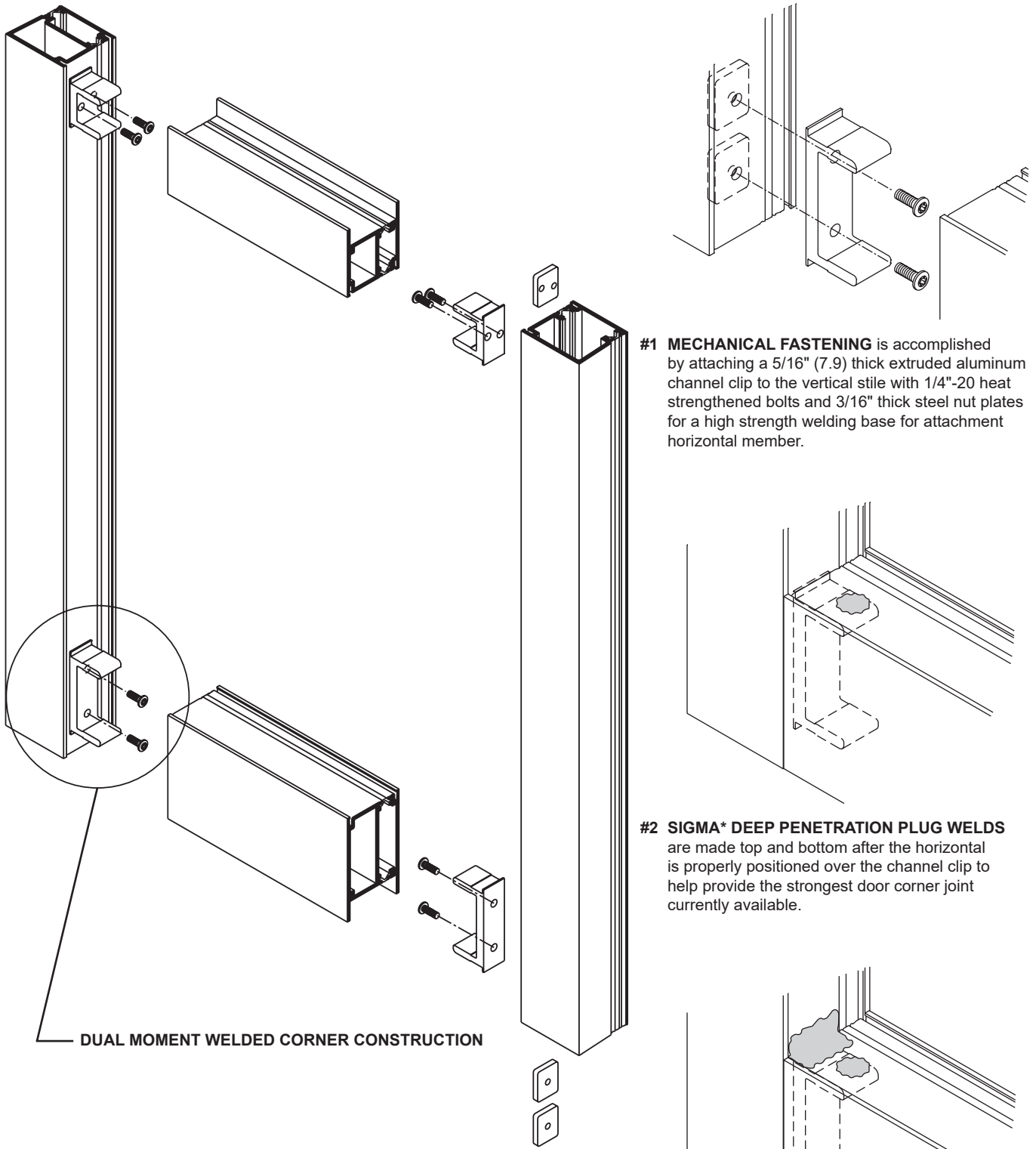

DUAL MOMENT WELDED CORNER CONSTRUCTION

#1 MECHANICAL FASTENING is accomplished by attaching a 5/16" (7.9) thick extruded aluminum channel clip to the vertical stile with 1/4"-20 heat strengthened bolts and 3/16" thick steel nut plates for a high strength welding base for attachment horizontal member.

#2 SIGMA* DEEP PENETRATION PLUG WELDS are made top and bottom after the horizontal is properly positioned over the channel clip to help provide the strongest door corner joint currently available.

#3 SIGMA* FILLET WELDS along both top and bottom webs of the rail extrusion complete the Dual Welded corner construction.

* An arc welding process known as Shielded Inert Gas Metal Arc (SIGMA) or also known as Metal Inert Gas (MIG).

Additional information and CAD details are available at www.kawneer.com

250 NARROW STILE

425 WIDE STILE

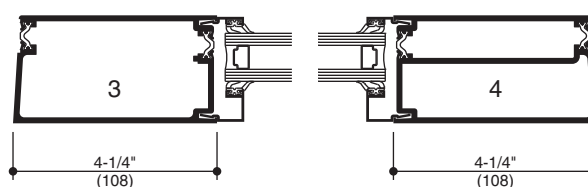
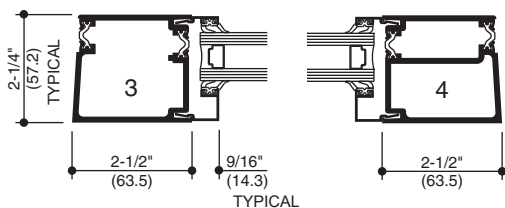
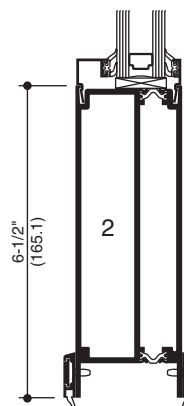
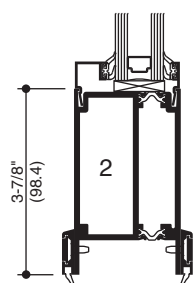
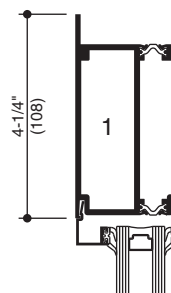
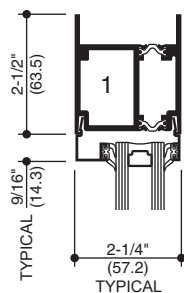
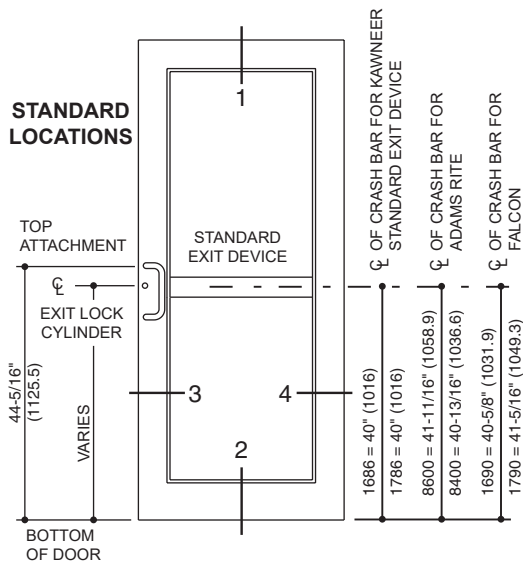
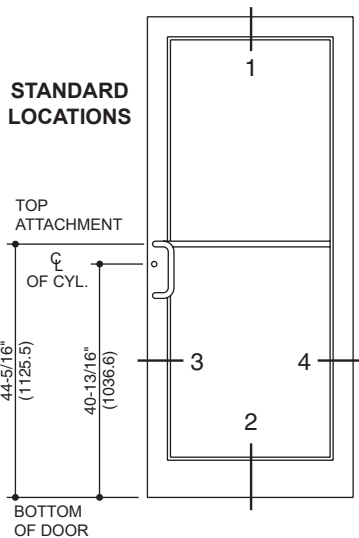

LOCK STILE

PIVOT STILE

LOCK STILE

PIVOT STILE

Laws and building and safety codes governing the design and use of Kawneer products, such as glazed entrance, window, and curtain wall products, vary widely. Kawneer does not control the selection of product configurations, operating hardware, or glazing materials, and assumes no responsibility therefor.

Kawneer reserves the right to change configuration without prior notice when deemed necessary for product improvement.
© 2015, Kawneer Company, Inc.

Additional information and CAD details are available at www.kawneer.com

**AA®250 THERMAL ENTRANCE DOORS
SINGLE ACTING
TRIFAB® VG 451T CENTER DOOR FRAMES SHOWN**

NOTE:

1. NARROW STILE AA®250 THERMAL ENTRANCES ARE DETAILED, WIDE STILE AA®425 THERMAL ENTRANCES ALSO MAY BE USED.
2. TRIFAB® VG 451T CENTER, 2" X 4-1/2" (50.8 X 114.3) FRAMING IS DETAILED WITH THE DOORS FOR REFERENCE. OTHER KAWNEER FRAMING SERIES OR CURTAIN WALL SYSTEMS MAY BE USED. REFER TO THE CATALOG INDEX FOR THE APPROPRIATE DETAIL SECTION.

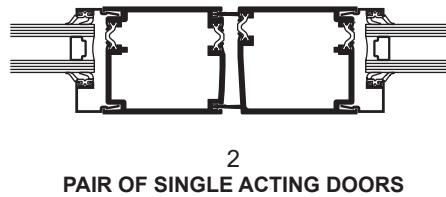
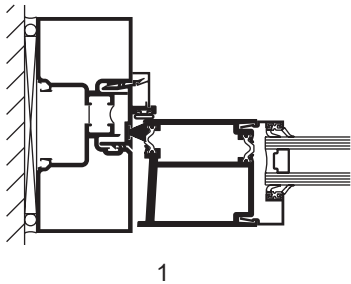
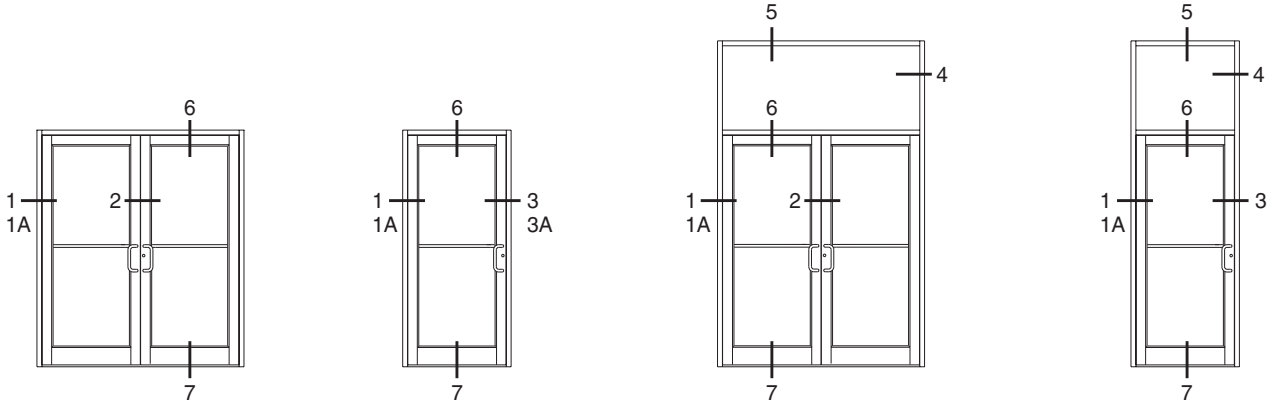

5
TRANSOM HEAD

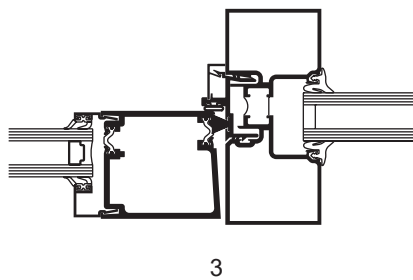
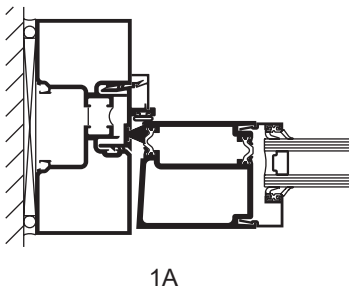
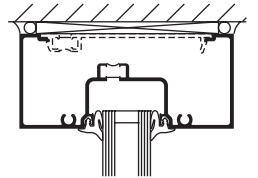

6
DOOR HEADER/
TRANSOM BAR

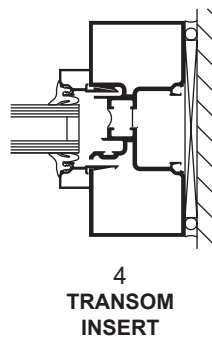
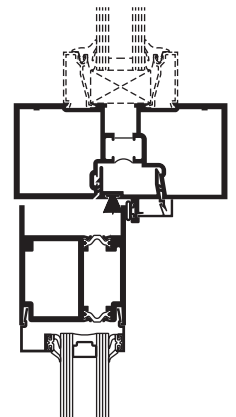

7*
BOTTOM RAIL

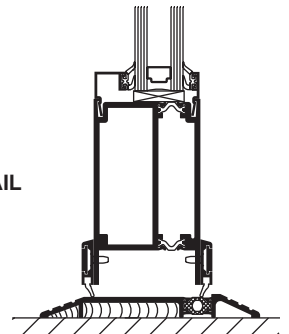

*NOTE: Some building codes limit threshold height to 1/2" (12.7) max.

Laws and building and safety codes governing the design and use of Kawneer products, such as glazed entrance, window, and curtain wall products, vary widely. Kawneer does not control the selection of product configurations, operating hardware, or glazing materials, and assumes no responsibility therefor.

Kawneer reserves the right to change configuration without prior notice when deemed necessary for product improvement.
© 2015, Kawneer Company, Inc.

Additional information and CAD details are available at www.kawneer.com

TRIFAB[®] VG 451T CENTER DOOR FRAMES

DIMENSIONS ARE NOMINAL

SINGLE ACTING DOORS

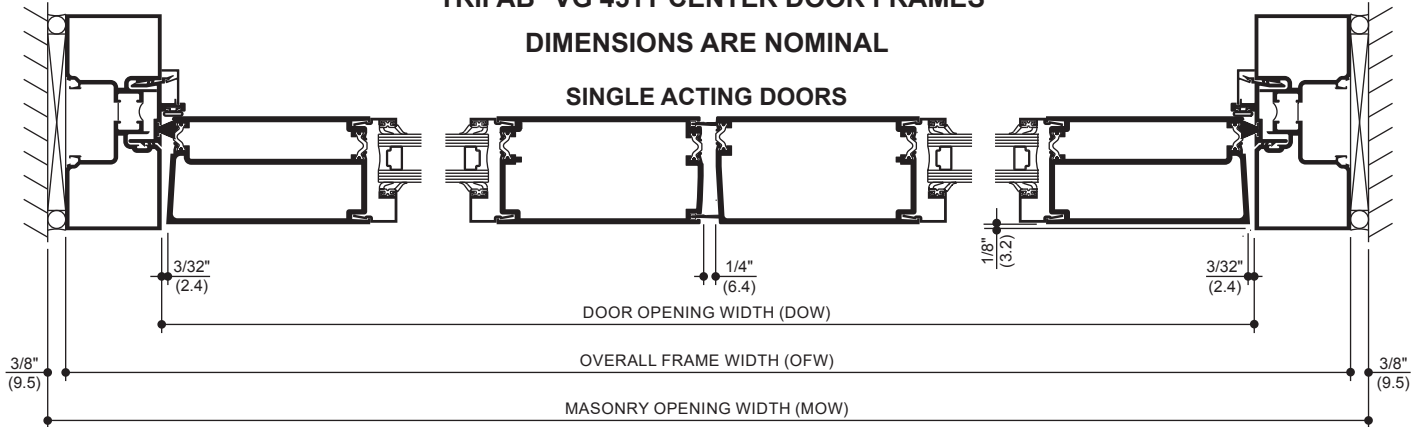

TRANSOM JAMBS

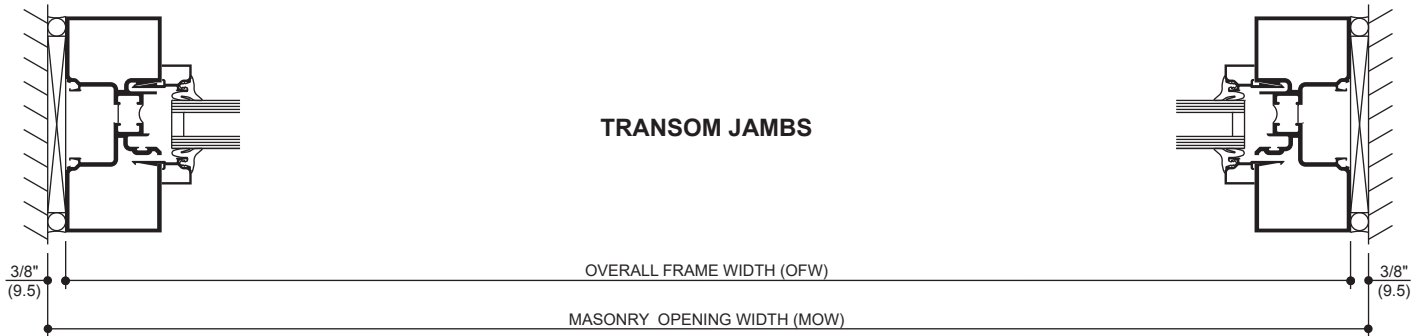

CONTINUOUS HINGE JAMB

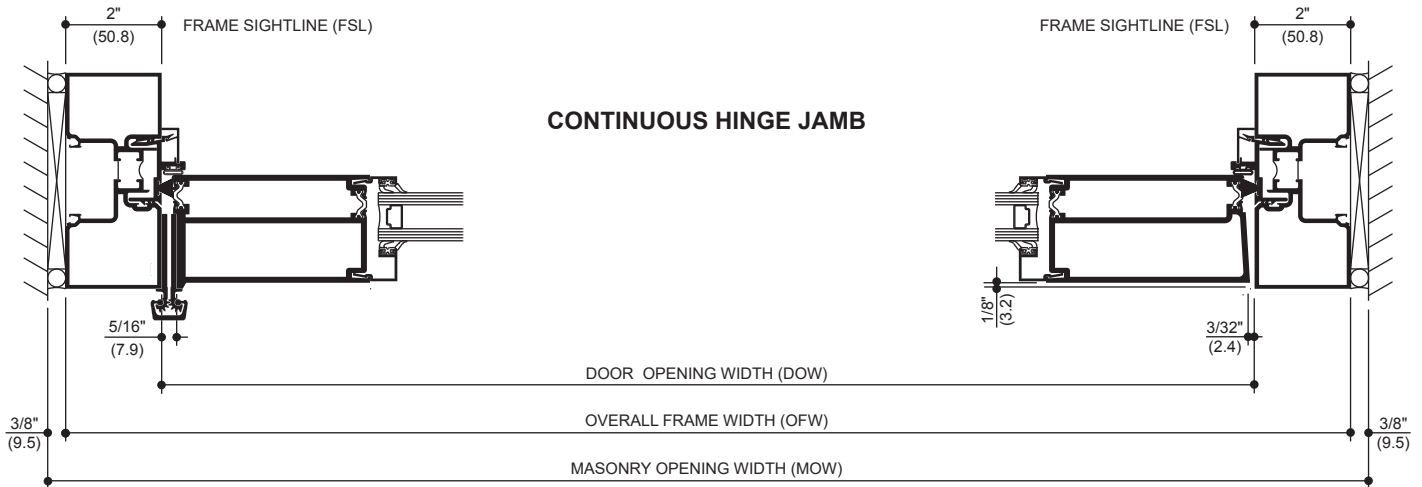

STANDARD SIZES (TRIFAB[®] VG 451T CENTER FRAMES)

WITH AND WITHOUT TRANSOM

Door Opening Dimension (DOW)	
3' 0"	(914)
3' 6"	(1,067)
6' 0"	(1,829)

Overall Frame Dimension (OFW)	
3' 4"	(1,016)
3' 10"	(1,168)
6' 4"	(1,930)

Masonry Opening Dimension (MOW)	
3' 4-3/4"	(1,035)
3' 10-3/4"	(1,187)
6' 4-3/4"	(1,949)

WITH AND WITHOUT TRANSOM

OFW = DOW + 2 FSL

MOW = OFW + 3/4"

Note: Dimensions shown above reflect A1 Price Book standard stock door frame height with transom at 10' 3-1/2" (3,137).

Laws and building and safety codes governing the design and use of Kawneer products, such as glazed entrance, window, and curtain wall products, vary widely. Kawneer does not control the selection of product configurations, operating hardware, or glazing materials, and assumes no responsibility therefor.

Kawneer reserves the right to change configuration without prior notice when deemed necessary for product improvement.
© 2015, Kawneer Company, Inc.

Additional information and CAD details are available at www.kawneer.com

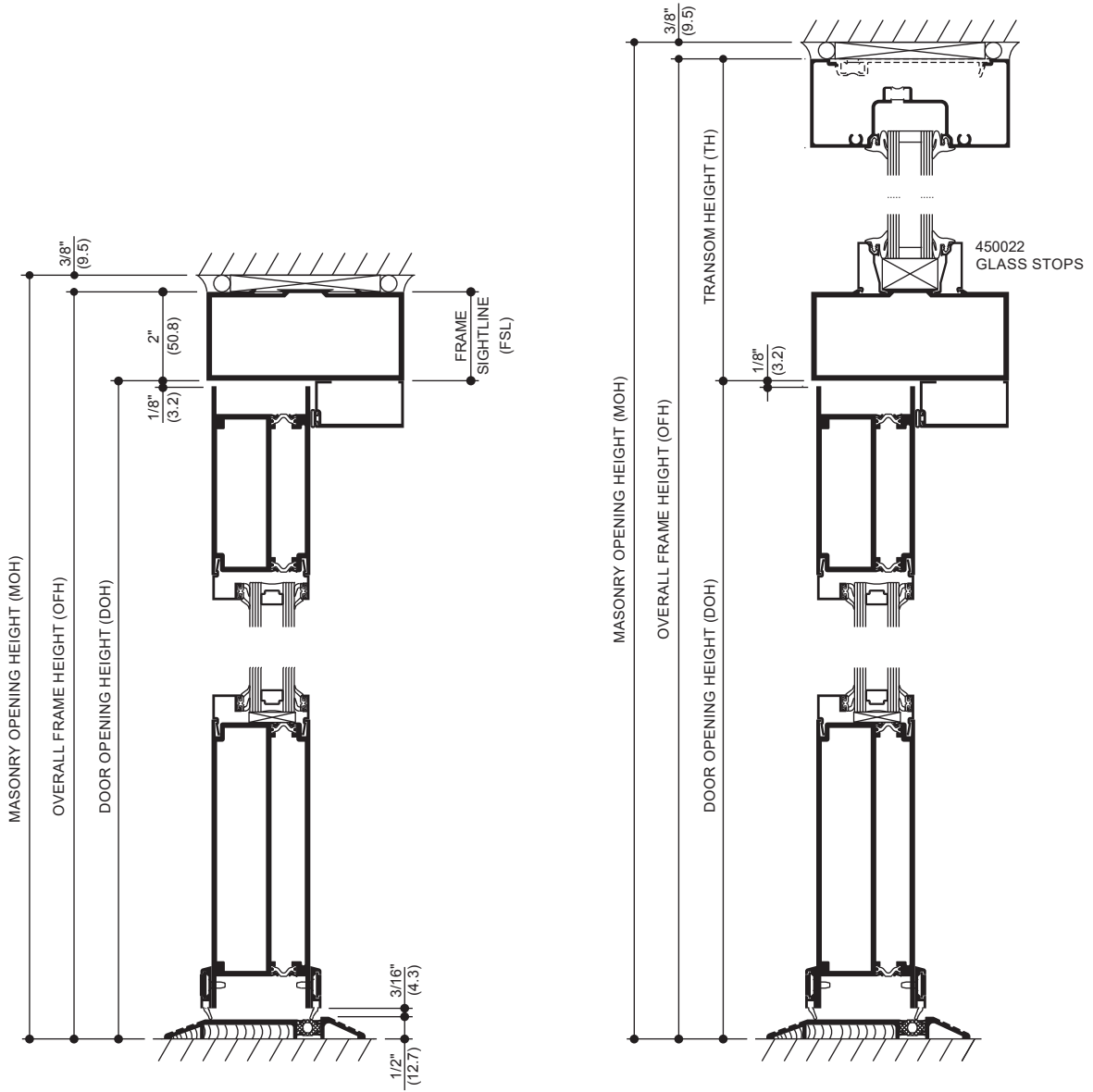

STANDARD SIZES (TRIFAB® VG 451T CENTER FRAMES)

WITHOUT TRANSOM

Door Opening Dimension (DOH)	
7' 0"	(2,134)
7' 0"	(2,134)
7' 0"	(2,134)

Overall Frame Dimension (OFH)	
7' 2"	(2,184)
7' 2"	(2,184)
7' 2"	(2,184)

Masonry Opening Dimension (MOH)	
7' 2-3/8"	(2,194)
7' 2-3/8"	(2,194)
7' 2-3/8"	(2,194)

WITHOUT TRANSOM

OFH = DOH + FSL
 MOH = OFH + 3/8"

WITH TRANSOM

OFH = DOH + TH
 MOH = OFH + 3/8"

Note: Dimensions shown above reflect A1 Price Book standard stock door frame height with transom at 10' 3-1/2" (3,137).

Laws and building and safety codes governing the design and use of Kawneer products, such as glazed entrance, window, and curtain wall products, vary widely. Kawneer does not control the selection of product configurations, operating hardware, or glazing materials, and assumes no responsibility therefor.

Kawneer reserves the right to change configuration without prior notice when deemed necessary for product improvement.

© 2015, Kawneer Company, Inc.

	STANDARD	OPTIONAL
Doors	Narrow stile 250 doors prepared for attachment hardware.	Wide stile 425.
Door Sizes Std.	Standard sizes shown on pages 8 and 9.	Any size up to 3' 6" x 8' 0" (1,067 x 2,438).
Glass Stops	Square glass stops for 1" (25.4) infill.	
Door Frames	Trifab [®] VG 451T Center - 2" x 4-1/2" (50.8 x 114.3) for double glazing.	Other Kawneer framing system suitable for door frames may be selected, but manufactured per order.
Push-Pulls	Single Acting: Architects Classic Hardware CO-9 Pull and CP-II Push Bar. Architects Classic Hardware CO-9 Pull and CP Push Bar.	Single Acting: Architects Classic Hardware CO-12 and CP-II push bar. Architects Classic Hardware CO-12 and CP push bar. Architects Classic Hardware CO-9/CO-9 Pulls. Architects Classic Hardware CO-12/CO-12 Pulls.
Door Closers	Single Acting: Norton 1601 adjustable or 1601 BF adjustable surface closer with back-check and with or without adjustable hold-open.	Single Acting: LCN 1260 adjustable surface closer. LCN 4040 surface closer with or without adjustable hold-open. Standard COC with single scing offset arm. Norton 8100 surface closer with a 50% spring power adjustment (for opening forces of less than 8 pounds). Closer is available with standard back-checks and with or without the hold-open feature. Falcon SC 60 Surface closer.
Hinging	Single Acting: Kawneer top and bottom offset pivots (or) Kawneer top and bottom 4-1/2" x 4" (114.3 x 101.6) ball bearing butt hinge with non-removable pin (NRP) (or) Kawneer continuous gear hinge.	
Intermediate Pivots/Butts	Single Acting: Kawneer intermediate offset pivot (or) Kawneer 4-1/2" x 4" (114.3 x 101.6) ball bearing butt hinge with non-removable pin (NRP).	Single Acting: Rixson M-19 or IVES #7215-INT intermediate offset pivot.
Locks - Active Leaf	Adams-Rite MS 1850A deadlock with two 1-5/32" (29.4) diameter 5 pin cylinders.	Adams-Rite #4510 Latch Lock. Adams-Rite #1850A-500 Short Throw Deadlock. Adams-Rite #1850A-505 Hookbolt Lock. Adams-Rite #4015 Two-point Lock. Adams-Rite #4015 & 4016 three-point lock. Adams-Rite #7130 Electric Strike. Kawneer Cylinder Guard. Kawneer Thumbturn (in lieu of cylinder).

Laws and building and safety codes governing the design and use of Kawneer products, such as glazed entrance, window, and curtain wall products, vary widely. Kawneer does not control the selection of product configurations, operating hardware, or glazing materials, and assumes no responsibility therefor.

Kawneer reserves the right to change configuration without prior notice when deemed necessary for product improvement.
© 2015, Kawneer Company, Inc.

	STANDARD	OPTIONAL
Locks - Inactive Leaf	One pair of Kawneer flush bolts in the inactive leaf of a pair of doors.	
Thresholds	A 1/2" x 4-1/2" (12.7 x 114.3) aluminum mill finish threshold.	
Weathering	Single Acting: Weathering system in the door and frame consisting of a dense, bulb polymeric material, which remains resilient and retains its weathering ability under temperature extremes. Complete with an optional EPDM blade gasket sweep strip applied to both the interior and exterior of the bottom rail with concealed fasteners.	
Exit Device	<p>Kawneer 1686 Concealed Rod Exit Device with or without a mortised type cylinder.</p> <p>Kawneer 1786 Rim Exit Device is a rim type exit device with or without a rim type cylinder.</p>	<p>Kawneer 1686 CD concealed rod exit device available with cylinder dogging.</p> <p>Kawneer 1786 CD rim exit device available with cylinder dogging.</p> <p>Adams-Rite 8600 concealed rod exit device.</p> <p>Adams-Rite 8400 rim exit device.</p> <p>Falcon 1690 Concealed Rod Exit Device with or without rim type cylinder.</p> <p>Falcon 1790 Rim Exit Device rim type exit device with or without a rim type cylinder.</p> <p>Falcon EL 1690 concealed rod exit device with or without a rim type cylinder. The device is designed for electrified access control and is compatible with most key pad and card reader systems.</p> <p>Falcon EL 1790 rim type exit device with or without a rim type cylinder. The device is designed for electrified access control and is compatible with most key pad and card reader systems.</p> <p>Falcon 1990 is a concealed rod exit device with or without a rim type cylinder.</p> <p>Falcon 2090 is a rim type exit device with or without a rim type cylinder.</p> <p>Von Duprin 33 concealed rod exit device with or without night latch assembly.</p> <p>Von Duprin 99 concealed rod exit device with or without night latch assembly.</p>
	Exit Device Pulls: Architects Classic CO-9 Pull.	Optional Exit Device Pulls: Architects Classic CO-12 Pull.

Reference Hardware section for additional information

Laws and building and safety codes governing the design and use of Kawneer products, such as glazed entrance, window, and curtain wall products, vary widely. Kawneer does not control the selection of product configurations, operating hardware, or glazing materials, and assumes no responsibility therefor.

Kawneer reserves the right to change configuration without prior notice when deemed necessary for product improvement.
© 2015, Kawneer Company, Inc.

ARCHITECTS CLASSIC (PUSH PULL SETS)

SINGLE ACTING DOORS USE A PULL HANDLE AND PUSH BAR.

Refer to **HARDWARE SECTION** for complete hardware information.

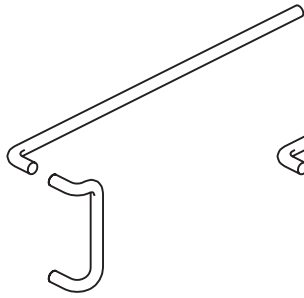

CO-9 / CP
CO-12 / CP

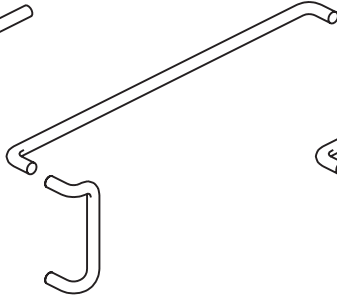

CO-9 / CP-II
CO-12 / CP-II

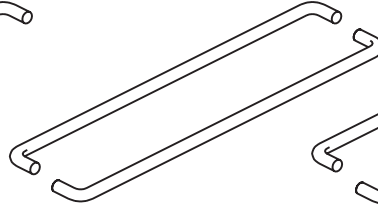

CP-II / CP-II

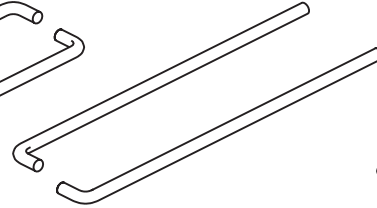

CP / CP

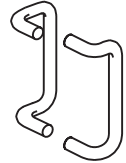

CO-9 / CO-9
CO-12 / CO-12

ARCHITECTS CLASSIC (COMPONENTS)

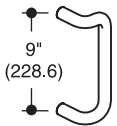

CO-9 PULL

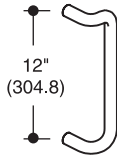

CO-12 PULL

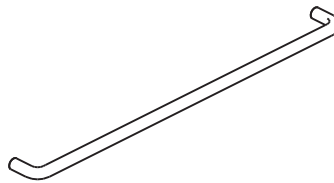

CP-II PUSH BAR

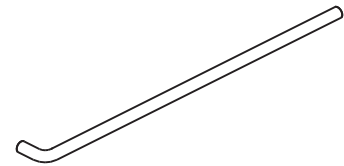

CP PUSH BAR

Laws and building and safety codes governing the design and use of Kawneer products, such as glazed entrance, window, and curtain wall products, vary widely. Kawneer does not control the selection of product configurations, operating hardware, or glazing materials, and assumes no responsibility therefor.

Kawneer reserves the right to change configuration without prior notice when deemed necessary for product improvement.
© 2015, Kawneer Company, Inc.

EXIT DEVICES and EXIT DEVICE PULLS

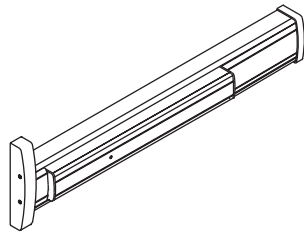

CONCEALED ROD EXIT DEVICE
Kawneer 1686
Kawneer 1686 CD

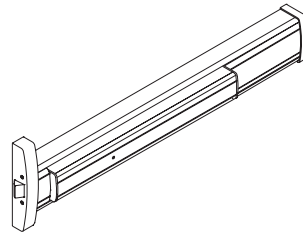

RIM LATCH EXIT DEVICE
Kawneer 1786
Kawneer 1786 CD

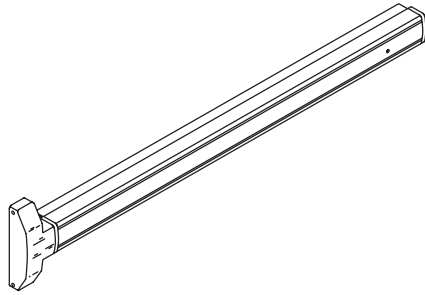

CONCEALED ROD EXIT DEVICE
Falcon 1690
Falcon EL 1690

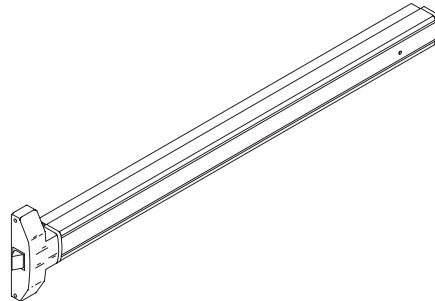

RIM LATCH EXIT DEVICE
Falcon 1790
Falcon EL 1790

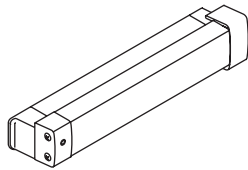

MORTISE EXIT DEVICE
Adams-Rite 8400

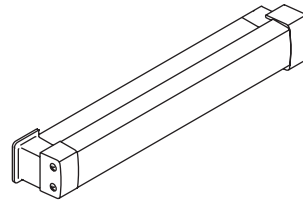

CONCEALED EXIT DEVICE
Adams-Rite 8600

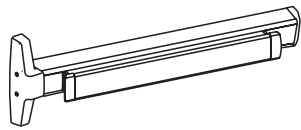

CONCEALED EXIT DEVICE
Von Duprin 3347A

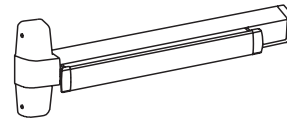

CONCEALED EXIT DEVICE
Von Duprin 9947

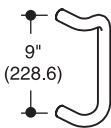

CO-9 PULL

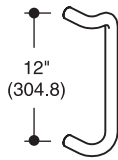

CO-12 PULL

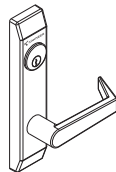

LEVER HANDLE
Kawneer 1686
Kawneer 1786

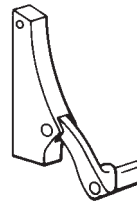

CONCEALED ROD EXIT DEVICE
Falcon 1990

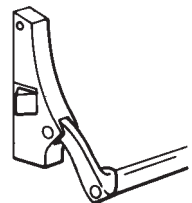

RIM LATCH EXIT DEVICE
Falcon 2090

Laws and building and safety codes governing the design and use of Kawneer products, such as glazed entrance, window, and curtain wall products, vary widely. Kawneer does not control the selection of product configurations, operating hardware, or glazing materials, and assumes no responsibility therefor.

Kawneer reserves the right to change configuration without prior notice when deemed necessary for product improvement.
© 2015, Kawneer Company, Inc.

Additional information and CAD details are available at www.kawneer.com

1-3/8" CROSSRAIL

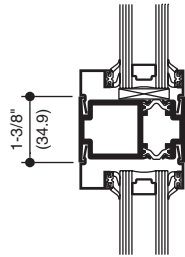

8-1/4" CROSSRAIL

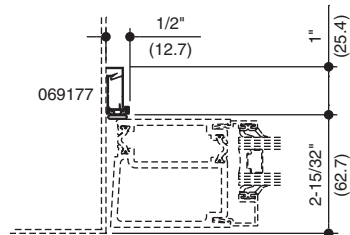
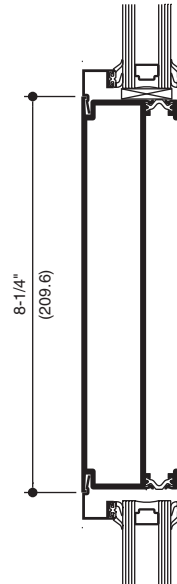

APPLIED DOOR STOP

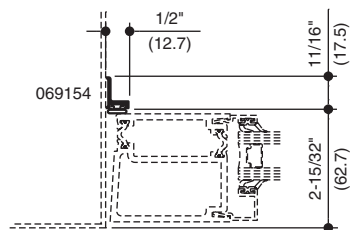

APPLIED DOOR STOP

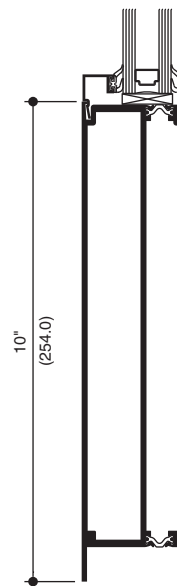

10" BOTTOM RAIL

Laws and building and safety codes governing the design and use of Kawneer products, such as glazed entrance, window, and curtain wall products, vary widely. Kawneer does not control the selection of product configurations, operating hardware, or glazing materials, and assumes no responsibility therefor.

Kawneer reserves the right to change configuration without prior notice when deemed necessary for product improvement.
© 2015, Kawneer Company, Inc.

**Generic Project Specific U-factor Example Calculation
(Percent of Glass will vary on specific products depending on sitelines)**

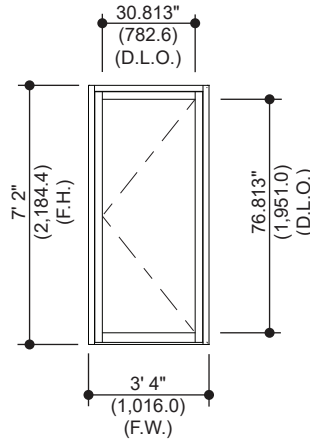

Example Glass U-Factor = 0.28 Btu/hr • ft² • °F

Total Daylight Opening = 30.813" x 76.813" = 16.44 ft²

Total Projected Area = 3' 4" x 7' 2" = 23.9 ft²

Percent of Glass = (Total Daylight Opening ÷ Total Projected Area)100
= (16.44 ÷ 23.9)100 = 68%

System U-factor vs Percent of Glass Area

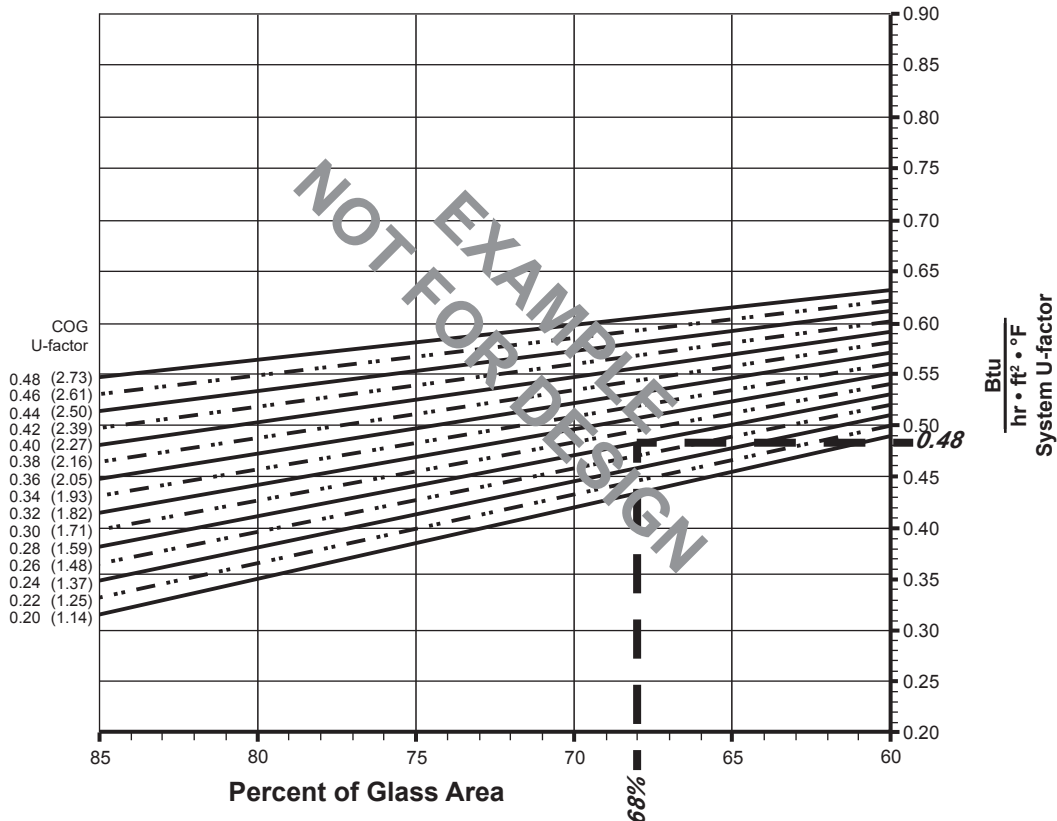

Based on 68% glass and center of glass (COG) U-factor of 0.28
System U-factor is equal to 0.48 Btu/hr • ft² • °F

Laws and building and safety codes governing the design and use of Kawneer products, such as glazed entrance, window, and curtain wall products, vary widely. Kawneer does not control the selection of product configurations, operating hardware, or glazing materials, and assumes no responsibility therefor.

Kawneer reserves the right to change configuration without prior notice when deemed necessary for product improvement.
© 2015, Kawneer Company, Inc.

AA[®]250 (SINGLE DOOR)

System U-factor vs Percent of Glass Area

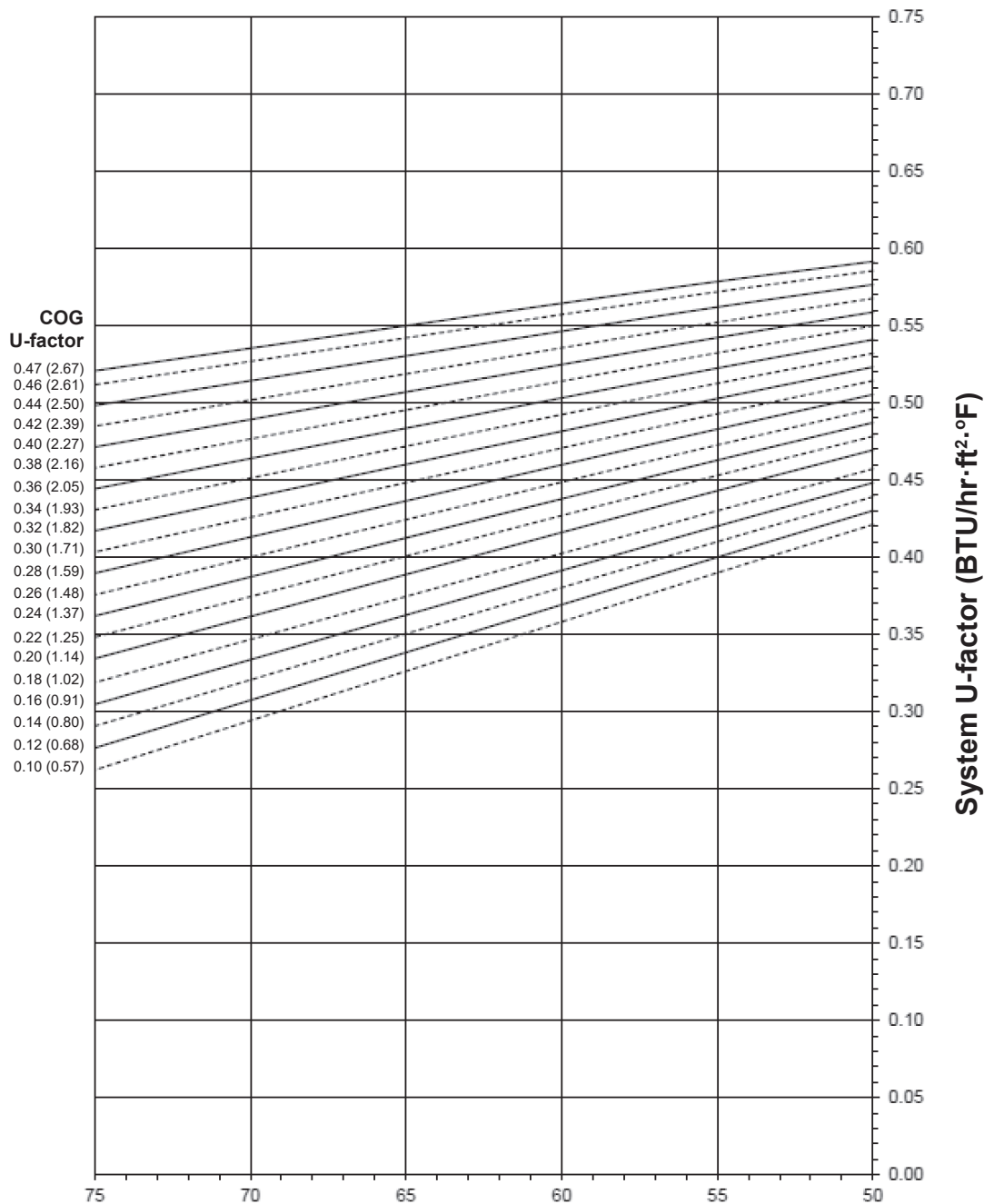

**Percent of Glass = Vision Area/Total Area
(Total Daylight Opening / Projected Area)**

Notes for System U-Factor, SHGC and VT charts:

For glass values that are not listed, linear interpolation is permitted.
Glass properties are based on center of glass values (winter conditions) and are obtained from your glass supplier.

Laws and building and safety codes governing the design and use of Kawneer products, such as glazed entrance, window, and curtain wall products, vary widely. Kawneer does not control the selection of product configurations, operating hardware, or glazing materials, and assumes no responsibility therefor.

Kawneer reserves the right to change configuration without prior notice when deemed necessary for product improvement.
© 2015, Kawneer Company, Inc.

AA® 250 (SINGLE DOOR)

System Solar Heat Gain Coefficient (SHGC) vs Percent of Vision Area

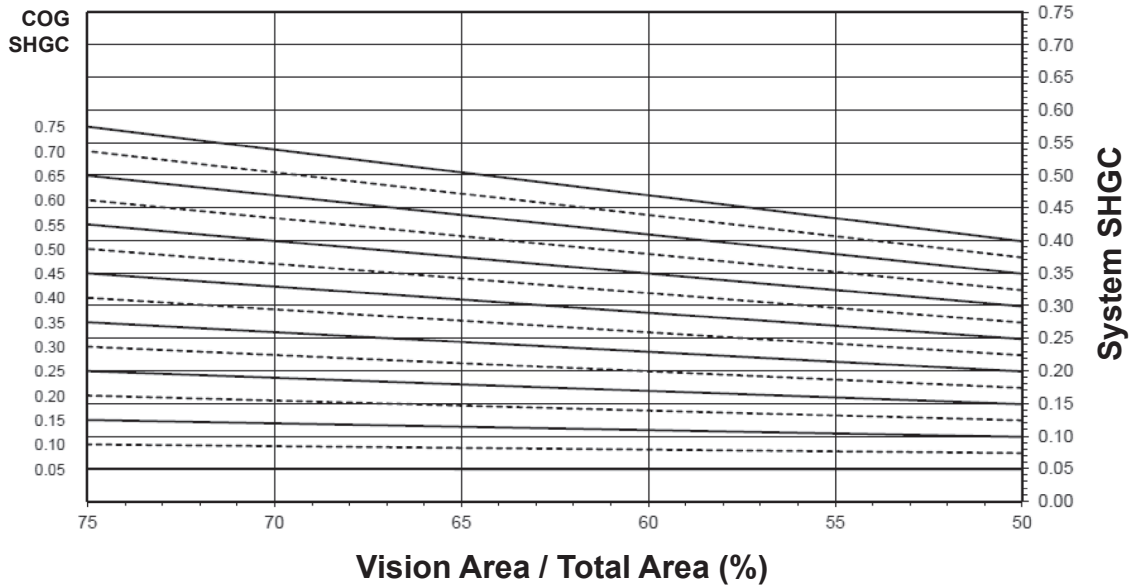

System Visible Transmittance (VT) vs Percent of Vision Area

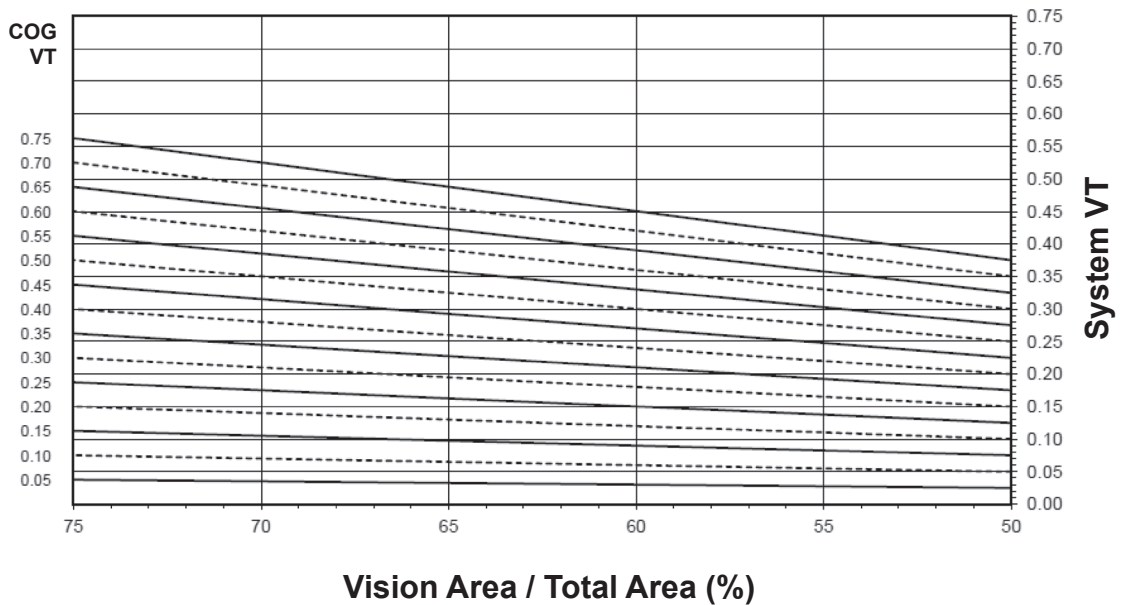

Laws and building and safety codes governing the design and use of Kawneer products, such as glazed entrance, window, and curtain wall products, vary widely. Kawneer does not control the selection of product configurations, operating hardware, or glazing materials, and assumes no responsibility therefor.

Kawneer reserves the right to change configuration without prior notice when deemed necessary for product improvement.
© 2015, Kawneer Company, Inc.

Thermal Transmittance ¹ (BTU/hr • ft² • °F)

Glass U-Factor ³	Overall U-Factor ⁴
0.48	0.57
0.46	0.57
0.44	0.55
0.42	0.54
0.40	0.53
0.38	0.52
0.36	0.51
0.34	0.50
0.32	0.49
0.30	0.48
0.28	0.47
0.26	0.46
0.24	0.46
0.22	0.44
0.20	0.43
0.18	0.42
0.16	0.41
0.14	0.40
0.12	0.39
0.10	0.38

AA®250 (SINGLE DOOR)

NOTE: For glass values that are not listed, linear interpolation is permitted.

1. U-Factors are determined in accordance with NFRC 100.
2. SHGC and VT values are determined in accordance with NFRC 200.
3. Glass properties are based on center of glass values and are obtained from your glass supplier.
4. Overall U-Factor, SHGC, and VT Matricies are based on the standard NFRC specimen size of 960 mm wide by 2,090 mm high (37-3/4" by 82-3/8").

SHGC Matrix ²

Glass SHGC ³	Overall SHGC ⁴
0.75	0.45
0.70	0.42
0.65	0.39
0.60	0.36
0.55	0.34
0.50	0.31
0.45	0.28
0.40	0.25
0.35	0.22
0.30	0.19
0.25	0.16
0.20	0.13
0.15	0.11
0.10	0.08
0.05	0.05

Visible Transmittance ²

Glass VT ³	Overall VT ⁴
0.75	0.43
0.70	0.40
0.65	0.37
0.60	0.34
0.55	0.31
0.50	0.29
0.45	0.26
0.40	0.23
0.35	0.20
0.30	0.17
0.25	0.14
0.20	0.11
0.15	0.09
0.10	0.06
0.05	0.03

Laws and building and safety codes governing the design and use of Kawneer products, such as glazed entrance, window, and curtain wall products, vary widely. Kawneer does not control the selection of product configurations, operating hardware, or glazing materials, and assumes no responsibility therefor.

Kawneer reserves the right to change configuration without prior notice when deemed necessary for product improvement.
© 2015, Kawneer Company, Inc.

AA® 250 (PAIR OF DOORS)

System U-factor vs Percent of Glass Area

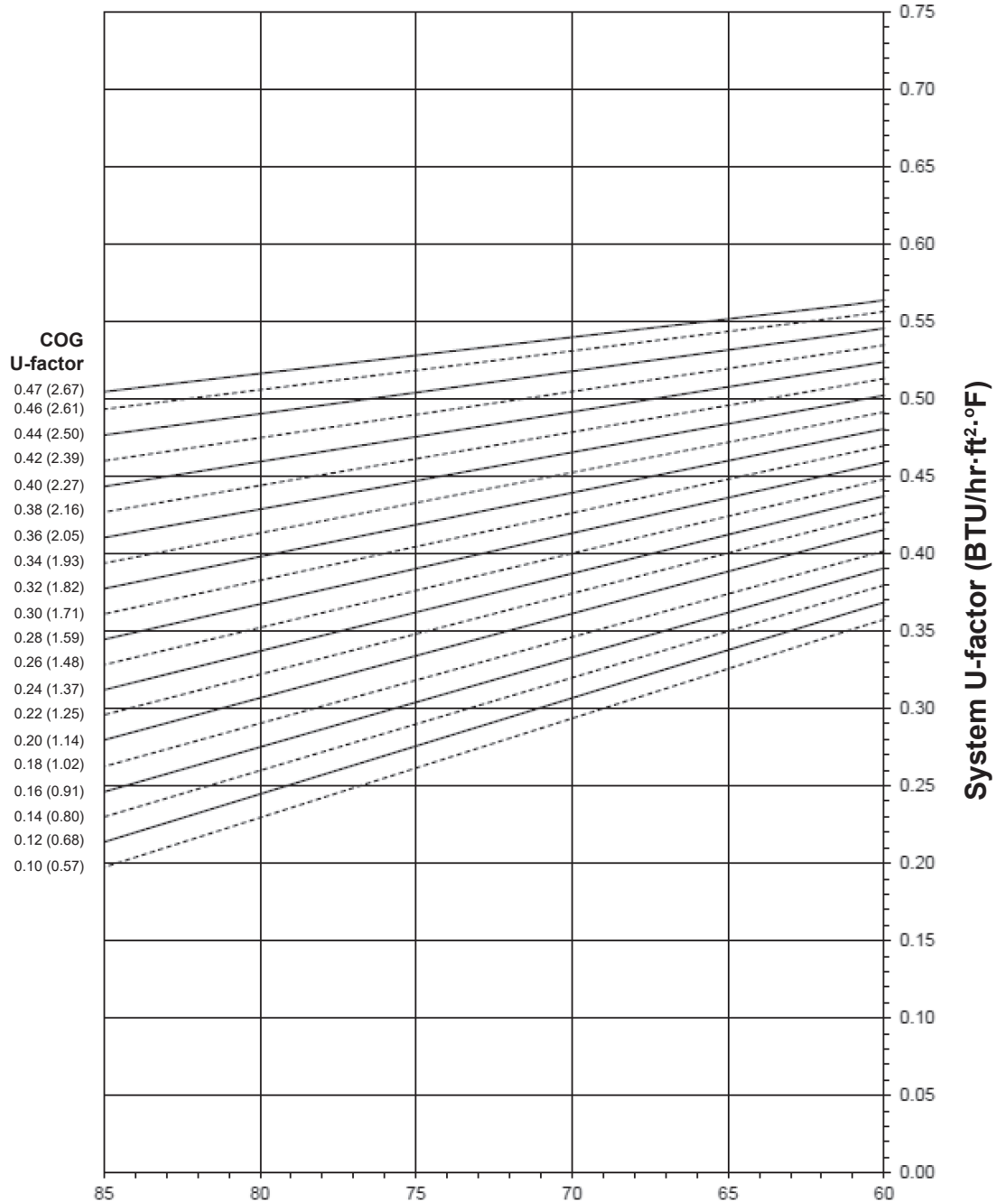

**Percent of Glass = Vision Area/Total Area
(Total Daylight Opening / Projected Area)**

Notes for System U-Factor, SHGC and VT charts:

For glass values that are not listed, linear interpolation is permitted.

Glass properties are based on center of glass values (winter conditions) and are obtained from your glass supplier.

Laws and building and safety codes governing the design and use of Kawneer products, such as glazed entrance, window, and curtain wall products, vary widely. Kawneer does not control the selection of product configurations, operating hardware, or glazing materials, and assumes no responsibility therefor.

Kawneer reserves the right to change configuration without prior notice when deemed necessary for product improvement.
© 2015, Kawneer Company, Inc.

AA®250 (PAIR OF DOORS)

System Solar Heat Gain Coefficient (SHGC) vs Percent of Vision Area

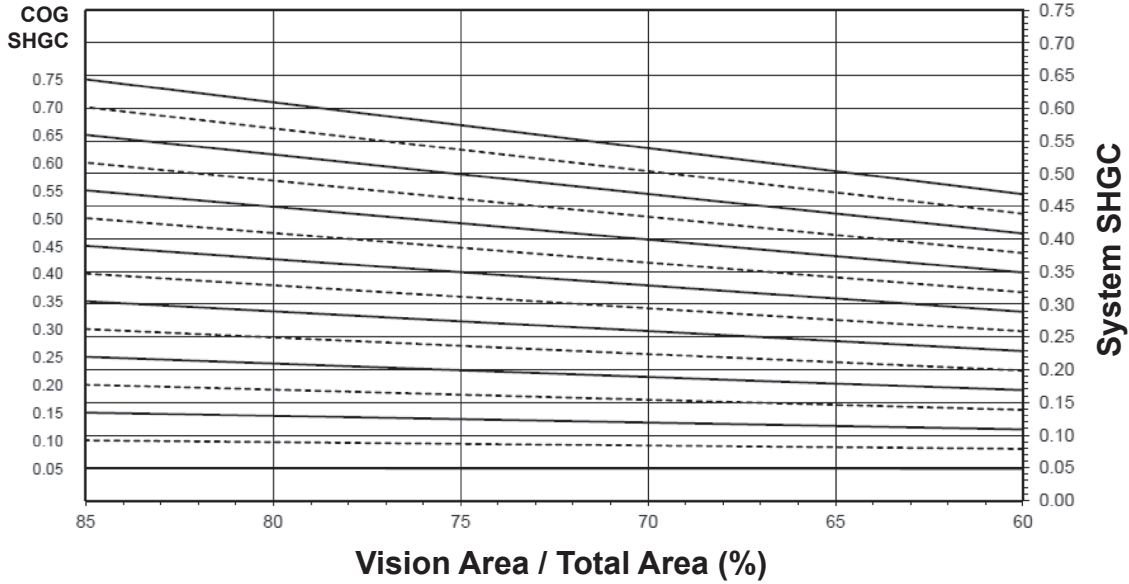

System Visible Transmittance (VT) vs Percent of Vision Area

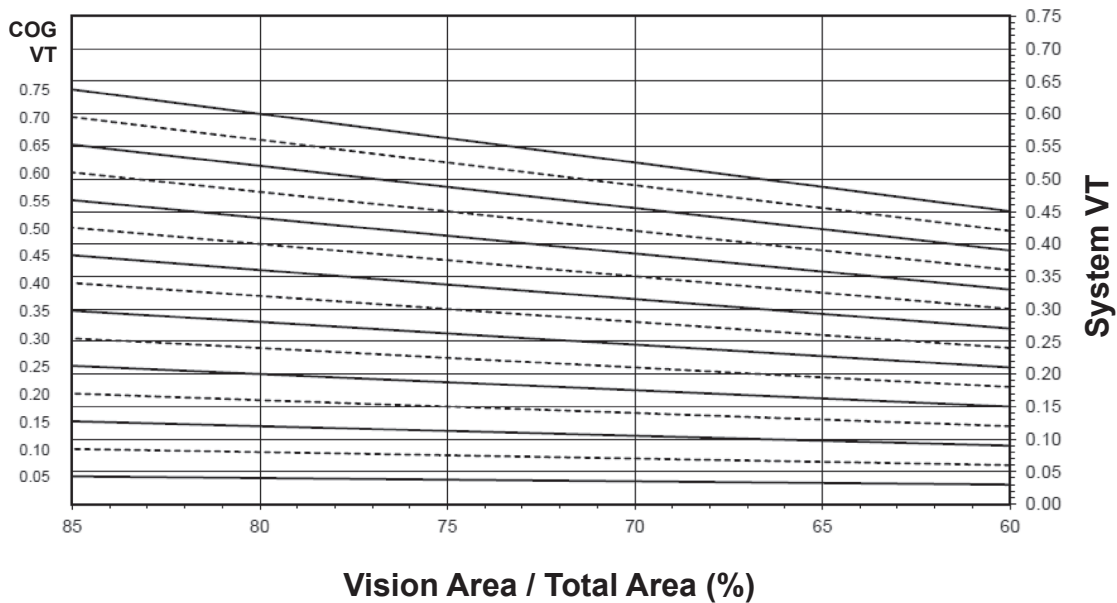

Laws and building and safety codes governing the design and use of Kawneer products, such as glazed entrance, window, and curtain wall products, vary widely. Kawneer does not control the selection of product configurations, operating hardware, or glazing materials, and assumes no responsibility therefor.

Kawneer reserves the right to change configuration without prior notice when deemed necessary for product improvement.
© 2015, Kawneer Company, Inc.

Thermal Transmittance ¹ (BTU/hr • ft² • °F)

AA®250 (PAIR OF DOORS)

Glass U-Factor ³	Overall U-Factor ⁴
0.48	0.56
0.46	0.55
0.44	0.54
0.42	0.53
0.40	0.52
0.38	0.51
0.36	0.50
0.34	0.49
0.32	0.48
0.30	0.46
0.28	0.45
0.26	0.44
0.24	0.43
0.22	0.42
0.20	0.41
0.18	0.39
0.16	0.38
0.14	0.37
0.12	0.36
0.10	0.35

NOTE: For glass values that are not listed, linear interpolation is permitted.

1. U-Factors are determined in accordance with NFRC 100.
2. SHGC and VT values are determined in accordance with NFRC 200.
3. Glass properties are based on center of glass values and are obtained from your glass supplier.
4. Overall U-Factor, SHGC, and VT Matricies are based on the standard NFRC specimen size of 1,920 mm wide by 2,090 mm high (75-1/2" by 82-3/8").

SHGC Matrix ²

Glass SHGC ³	Overall SHGC ⁴
0.75	0.48
0.70	0.45
0.65	0.42
0.60	0.39
0.55	0.36
0.50	0.32
0.45	0.29
0.40	0.26
0.35	0.23
0.30	0.20
0.25	0.17
0.20	0.14
0.15	0.11
0.10	0.08
0.05	0.05

Visible Transmittance ²

Glass VT ³	Overall VT ⁴
0.75	0.46
0.70	0.43
0.65	0.40
0.60	0.37
0.55	0.34
0.50	0.31
0.45	0.28
0.40	0.25
0.35	0.21
0.30	0.18
0.25	0.15
0.20	0.12
0.15	0.09
0.10	0.06
0.05	0.03

Laws and building and safety codes governing the design and use of Kawneer products, such as glazed entrance, window, and curtain wall products, vary widely. Kawneer does not control the selection of product configurations, operating hardware, or glazing materials, and assumes no responsibility therefor.

Kawneer reserves the right to change configuration without prior notice when deemed necessary for product improvement.
© 2015, Kawneer Company, Inc.

AA[®]425 (SINGLE DOOR)

System U-factor vs Percent of Glass Area

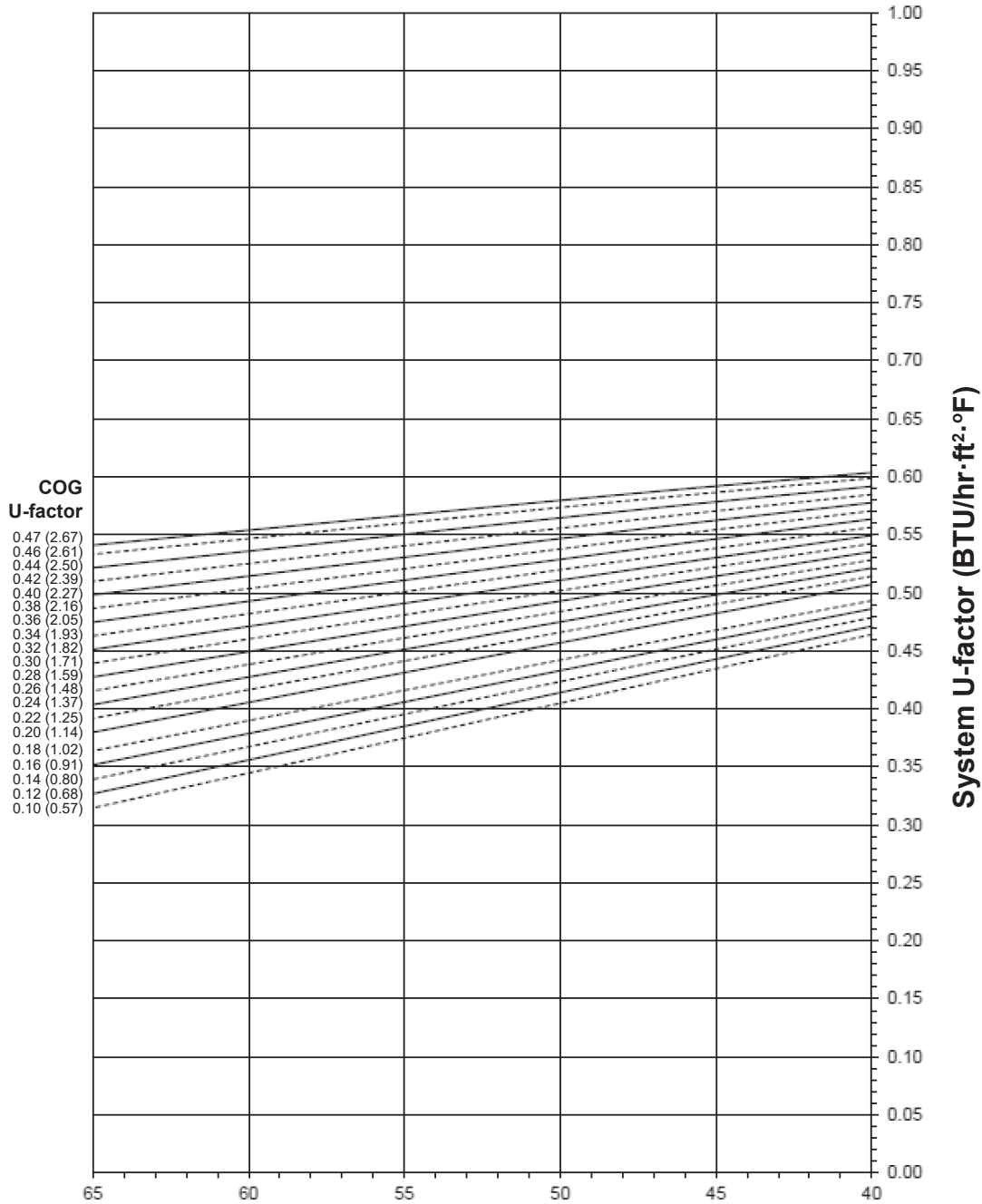

**Percent of Glass = Vision Area/Total Area
(Total Daylight Opening / Projected Area)**

Notes for System U-Factor, SHGC and VT charts:

- For glass values that are not listed, linear interpolation is permitted.
- Glass properties are based on center of glass values (winter conditions) and are obtained from your glass supplier.

Laws and building and safety codes governing the design and use of Kawneer products, such as glazed entrance, window, and curtain wall products, vary widely. Kawneer does not control the selection of product configurations, operating hardware, or glazing materials, and assumes no responsibility therefor.

Kawneer reserves the right to change configuration without prior notice when deemed necessary for product improvement.
© 2015, Kawneer Company, Inc.

AA® 425 (SINGLE DOOR)

System Solar Heat Gain Coefficient (SHGC) vs Percent of Vision Area

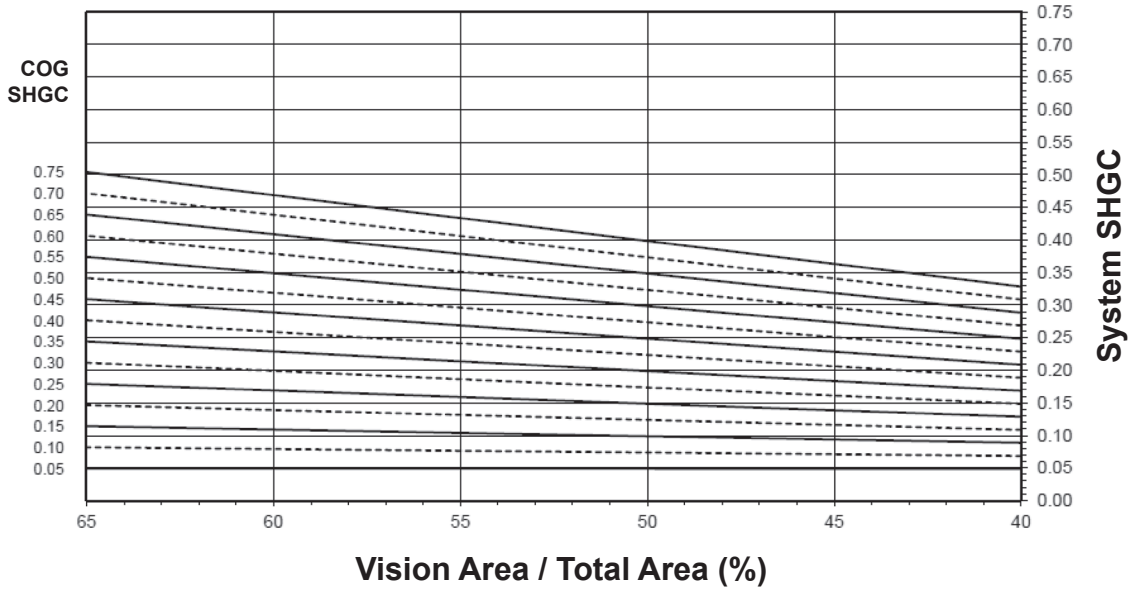

System Visible Transmittance (VT) vs Percent of Vision Area

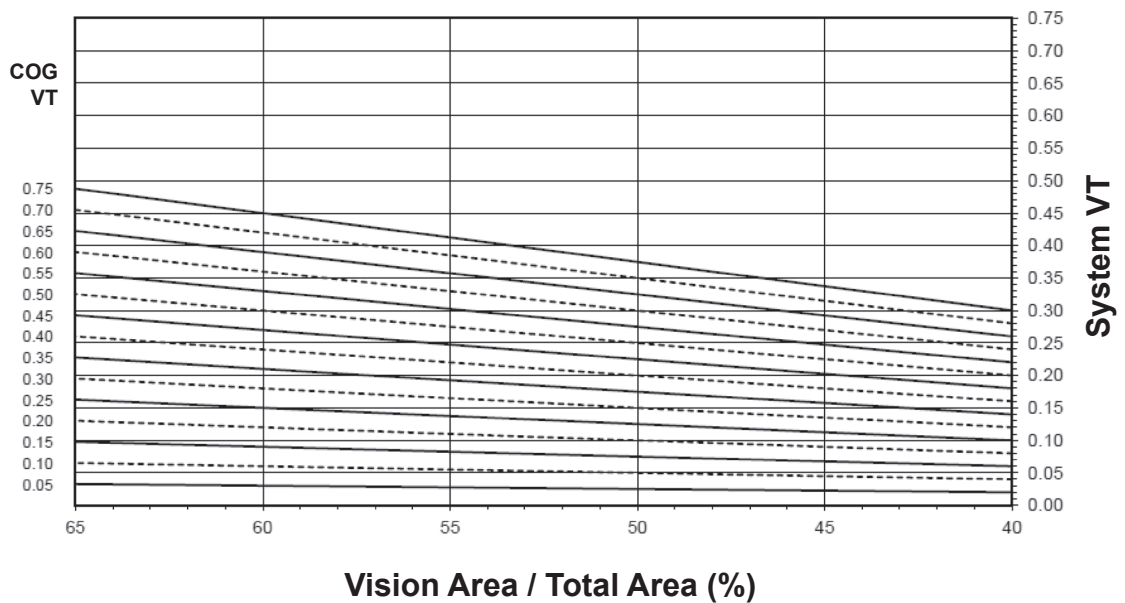

Laws and building and safety codes governing the design and use of Kawneer products, such as glazed entrance, window, and curtain wall products, vary widely. Kawneer does not control the selection of product configurations, operating hardware, or glazing materials, and assumes no responsibility therefor.

Kawneer reserves the right to change configuration without prior notice when deemed necessary for product improvement.
© 2015, Kawneer Company, Inc.

Thermal Transmittance ¹ (BTU/hr • ft² • °F)

Glass U-Factor ³	Overall U-Factor ⁴
0.48	0.58
0.46	0.58
0.44	0.57
0.42	0.56
0.40	0.55
0.38	0.54
0.36	0.53
0.34	0.52
0.32	0.51
0.30	0.51
0.28	0.50
0.26	0.49
0.24	0.48
0.22	0.47
0.20	0.46
0.18	0.44
0.16	0.43
0.14	0.43
0.12	0.42
0.10	0.41

AA®425 (SINGLE DOOR)

NOTE: For glass values that are not listed, linear interpolation is permitted.

1. U-Factors are determined in accordance with NFRC 100.
2. SHGC and VT values are determined in accordance with NFRC 200.
3. Glass properties are based on center of glass values and are obtained from your glass supplier.
4. Overall U-Factor, SHGC, and VT Matricies are based on the standard NFRC specimen size of 960 mm wide by 2,090 mm high (37-3/4" by 82-3/8").

SHGC Matrix ²

Glass SHGC ³	Overall SHGC ⁴
0.75	0.39
0.70	0.36
0.65	0.34
0.60	0.32
0.55	0.29
0.50	0.27
0.45	0.24
0.40	0.22
0.35	0.19
0.30	0.17
0.25	0.15
0.20	0.12
0.15	0.10
0.10	0.07
0.05	0.05

Visible Transmittance ²

Glass VT ³	Overall VT ⁴
0.75	0.36
0.70	0.34
0.65	0.32
0.60	0.29
0.55	0.27
0.50	0.24
0.45	0.22
0.40	0.19
0.35	0.17
0.30	0.15
0.25	0.12
0.20	0.10
0.15	0.07
0.10	0.05
0.05	0.02

Laws and building and safety codes governing the design and use of Kawneer products, such as glazed entrance, window, and curtain wall products, vary widely. Kawneer does not control the selection of product configurations, operating hardware, or glazing materials, and assumes no responsibility therefor.

Kawneer reserves the right to change configuration without prior notice when deemed necessary for product improvement.
© 2015, Kawneer Company, Inc.

AA®425 (PAIR OF DOORS)

System U-factor vs Percent of Glass Area

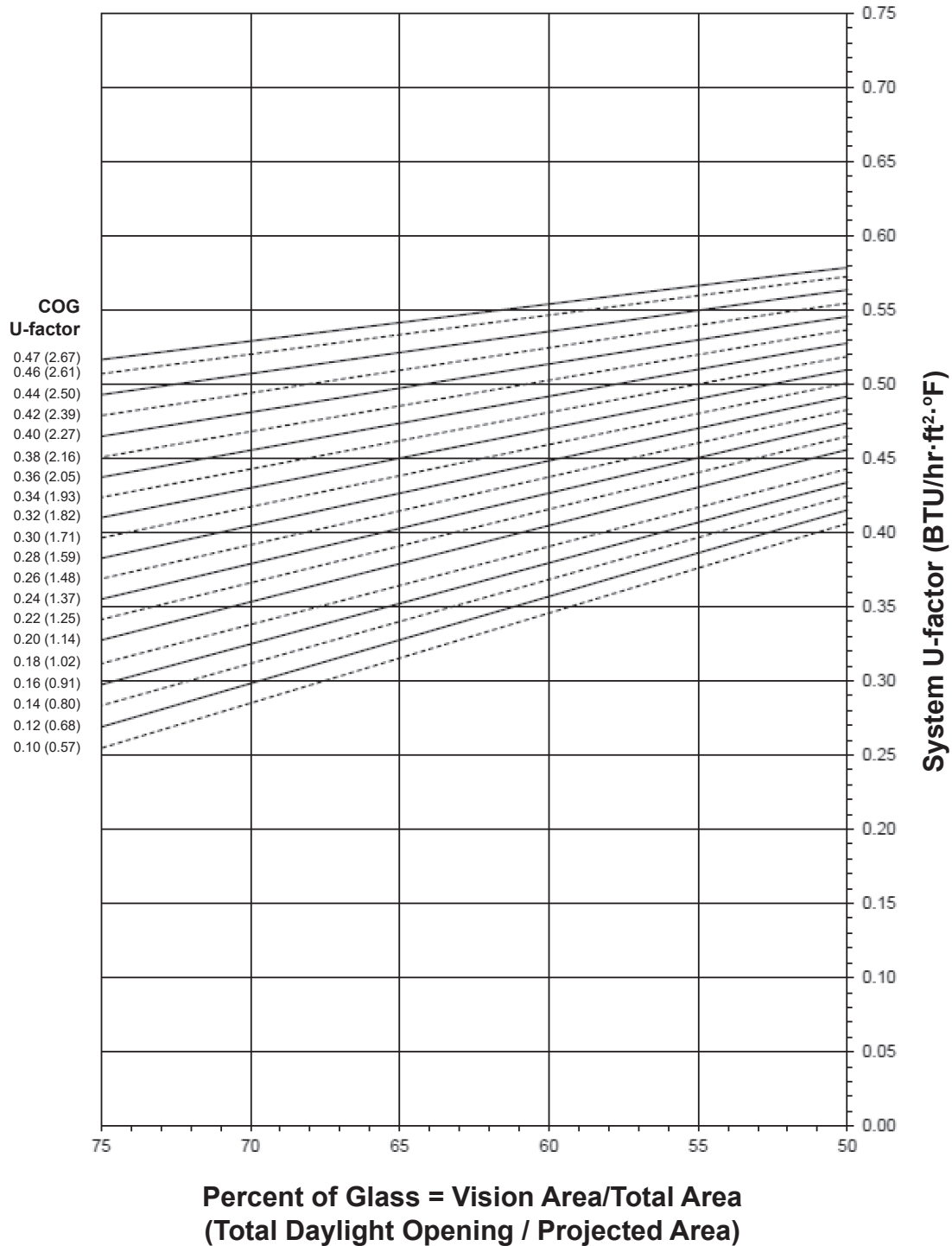

Notes for System U-Factor, SHGC and VT charts:

For glass values that are not listed, linear interpolation is permitted.

Glass properties are based on center of glass values (winter conditions) and are obtained from your glass supplier.

Laws and building and safety codes governing the design and use of Kawneer products, such as glazed entrance, window, and curtain wall products, vary widely. Kawneer does not control the selection of product configurations, operating hardware, or glazing materials, and assumes no responsibility therefor.

Kawneer reserves the right to change configuration without prior notice when deemed necessary for product improvement.
© 2015, Kawneer Company, Inc.

AA®425 (PAIR OF DOORS)

System Solar Heat Gain Coefficient (SHGC) vs Percent of Vision Area

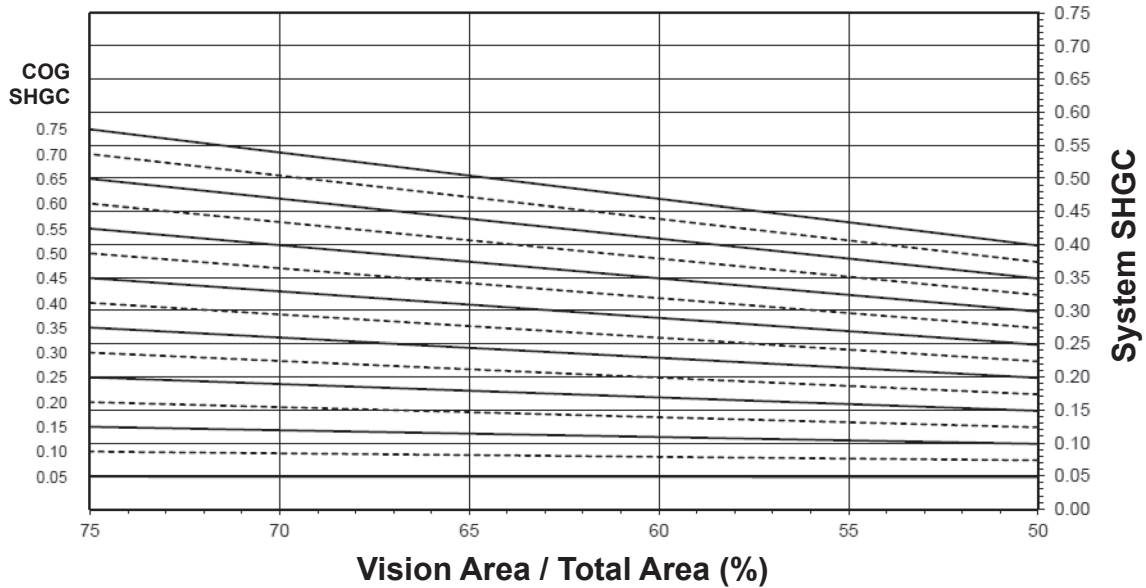

System Visible Transmittance (VT) vs Percent of Vision Area

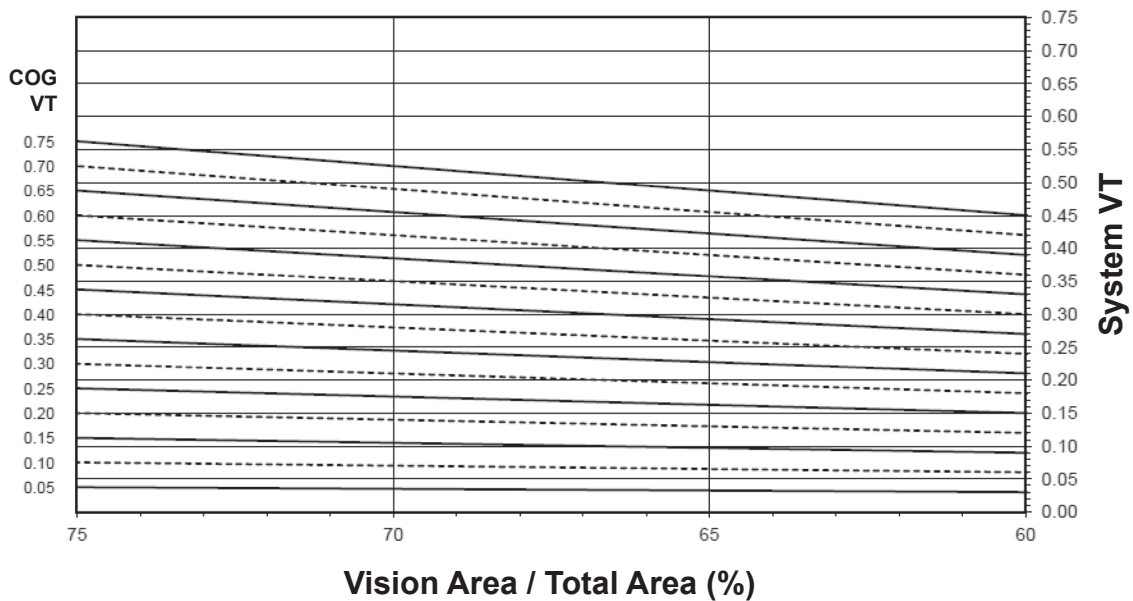

Laws and building and safety codes governing the design and use of Kawneer products, such as glazed entrance, window, and curtain wall products, vary widely. Kawneer does not control the selection of product configurations, operating hardware, or glazing materials, and assumes no responsibility therefor.

Kawneer reserves the right to change configuration without prior notice when deemed necessary for product improvement.
© 2015, Kawneer Company, Inc.

Thermal Transmittance ¹ (BTU/hr • ft ² • °F)

AA® 425 (PAIR OF DOORS)

Glass U-Factor ³	Overall U-Factor ⁴
0.48	0.57
0.46	0.57
0.44	0.56
0.42	0.55
0.40	0.54
0.38	0.53
0.36	0.52
0.34	0.51
0.32	0.50
0.30	0.49
0.28	0.48
0.26	0.47
0.24	0.46
0.22	0.45
0.20	0.44
0.18	0.43
0.16	0.42
0.14	0.41
0.12	0.40
0.10	0.39

NOTE: For glass values that are not listed, linear interpolation is permitted.

1. U-Factors are determined in accordance with NFRC 100.
2. SHGC and VT values are determined in accordance with NFRC 200.
3. Glass properties are based on center of glass values and are obtained from your glass supplier.
4. Overall U-Factor, SHGC, and VT Matricies are based on the standard NFRC specimen size of 1,920 mm wide by 2,090 mm high (75-1/2" by 82-3/8").

SHGC Matrix ²

Glass SHGC ³	Overall SHGC ⁴
0.75	0.42
0.70	0.39
0.65	0.36
0.60	0.34
0.55	0.31
0.50	0.28
0.45	0.26
0.40	0.23
0.35	0.21
0.30	0.18
0.25	0.15
0.20	0.13
0.15	0.10
0.10	0.07
0.05	0.05

Visible Transmittance ²

Glass VT ³	Overall VT ⁴
0.75	0.39
0.70	0.37
0.65	0.34
0.60	0.32
0.55	0.29
0.50	0.26
0.45	0.24
0.40	0.21
0.35	0.18
0.30	0.16
0.25	0.13
0.20	0.11
0.15	0.08
0.10	0.05
0.05	0.03

Laws and building and safety codes governing the design and use of Kawneer products, such as glazed entrance, window, and curtain wall products, vary widely. Kawneer does not control the selection of product configurations, operating hardware, or glazing materials, and assumes no responsibility therefor.

Kawneer reserves the right to change configuration without prior notice when deemed necessary for product improvement.
© 2015, Kawneer Company, Inc.

Laws and building and safety codes governing the design and use of Kawneer products, such as glazed entrance, window, and curtain wall products, vary widely. Kawneer does not control the selection of product configurations, operating hardware, or glazing materials, and assumes no responsibility therefor.

Kawneer reserves the right to change configuration without prior notice when deemed necessary for product improvement.
© 2015, Kawneer Company, Inc.